

Rev	AWO #	Description	Date	Appr
-		RELEASED	5/31/11	

APPROVED: _____
 DATE: _____ TITLE: _____

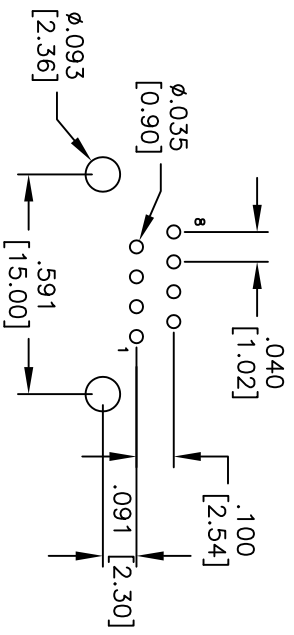
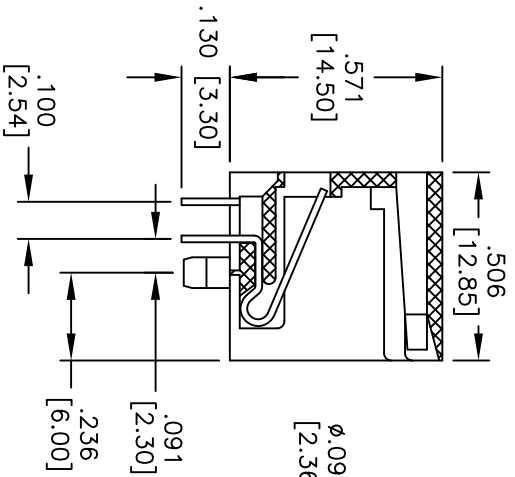
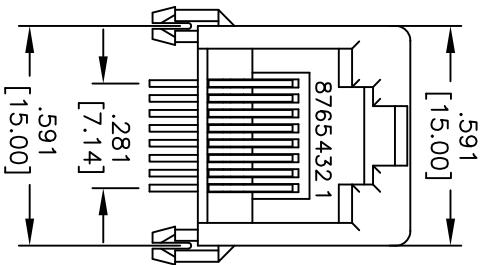
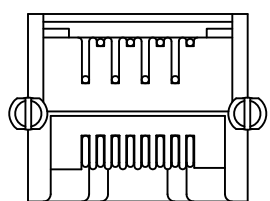

RECOMMENDED PCB LAYOUT

X	PLATING
0	15 µin Gold
1	30 µin Gold
2	50 µin Gold

SPECIFICATIONS:
 Material: Insulator: Hi-temp Nylon, rated UL 94V-0
 Insulator color: Black
 Contacts: Phosphor Bronze
 Plating: X u" Gold over Nickel underplate on tails (See chart)
 over Copper underplate on contact area, Tin
 Electrical:
 Operating voltage: 125 VAC max
 Current rating: 1.5 Amps max
 Contact resistance: 35 mohms max
 Insulation resistance: 1000 Mohms min @ 500 VDC
 Dielectric withstanding voltage: 1000 VAC for 1 minute
 Temperature Rating:
 Operating temperature: -40°C to +85°C



TITLE: MODULAR TELEPHONE JACK, 8P8C
 RIGHT ANGLE, PCB, COLOR BLACK

UNLESS OTHERWISE SPECIFIED ALL DIMENSIONS ARE INCHES [MM] TOLERANCES: EXCEPT AS NOTED			
.X	± .10	ØXX	± .10
.XX	± .020	ØXXX	± .015
.XXX	± .015	ØXXXX	± .010
INCHES			
HOLDS			
DATE			
APPROVALS			
DRAWN	AY	5/31/11	
CHECKED	AH	5/31/11	
APPROVED			

SIZE	PART NO.	REV.
X	MTJ-882BX1-HT-T/R	-

REF: S00009C SCALE: NTS SHEET 1 OF 2

6

5

4

3

2

1

Rev	AWO #	Description	Date	Appr
		SEE SHT 1 OF 2 FOR REVISION		

APPROVED: _____ TITLE: _____

DATE: _____

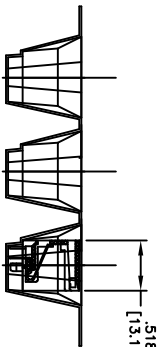
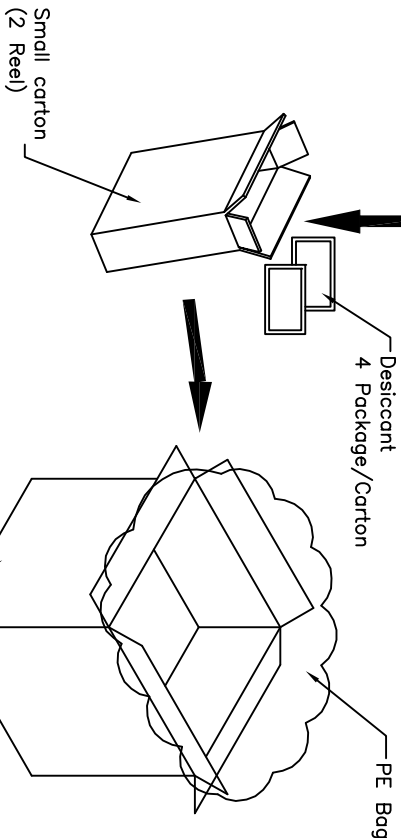
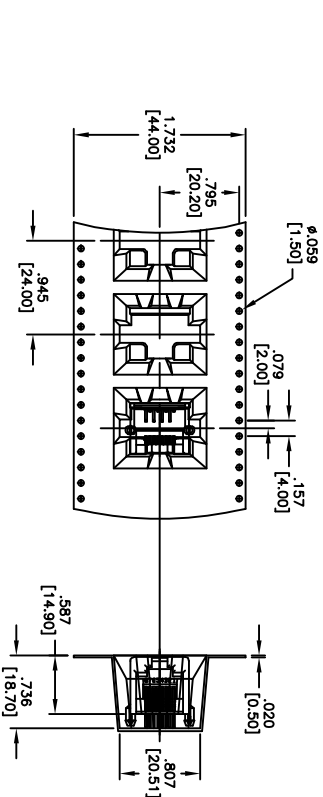
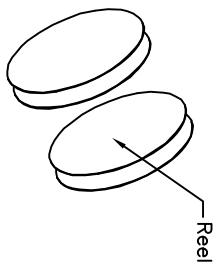
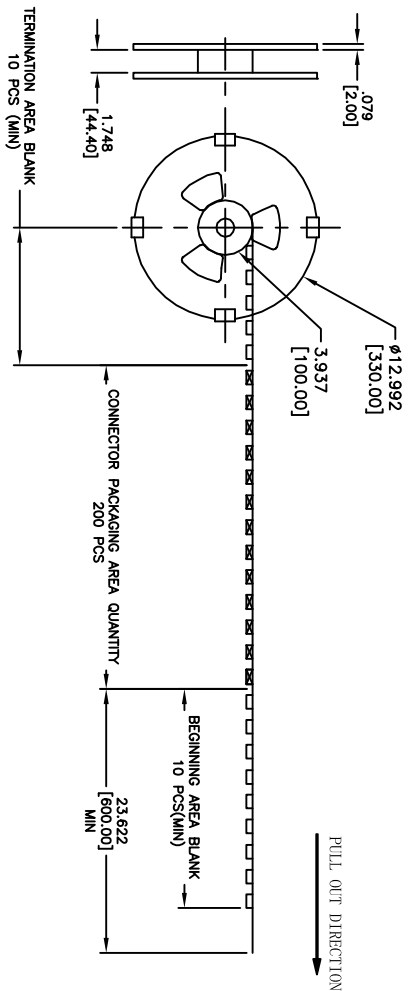

PACKAGED ON TAPE & REEL

ADAM TECH

909 Rahway Avenue, Union, NJ 07083
 Phone: 908-687-5000 Fax: 908-687-5710

TITLE: MODULAR TELEPHONE JACK, 8P8C
 RIGHT ANGLE, PCB, COLOR BLACK

- Small Carton Dimension: 33.5X10.5X33.5CM
- Small Carton: 2X200pcs=400pcs
- Big Carton Dimension: 33.5X33.5X59.5CM
- Big Carton: 10X200pcs=2000pcs
- PE Bag: 41.0*41.0*80.0CM

UNLESS OTHERWISE SPECIFIED
 ALL DIMENSIONS ARE IN INCHES [MM]
 TOLERANCES: EXCEPT AS NOTED

.X	± .10	ØXX	± .10
.XX	± .020	ØXXX	± .015
.XXX	± .015	ØXXXX	± .010

INCHES HOLES

APPROVALS		DATE
DRAWN	AY	5/31/11
CHECKED	AH	5/31/11
APPROVED		

SIZE	PART NO.	REV.
X	MTJ-882BX1-HT-TR	
REF:	S0008C	SCALE: NTS
SHEET 2 OF 2		

A

B

C

D

A

B

C

D

6

5

4

3

2

1