

MIL-DTL-5015 Mil-Spec Connectors

Part Number :

MS3102A14S-6P



Client Order no.: Item no. :
Order no. : Consignment no. :
Offer no. : Project :
Remarks :

Basic Information

Product Type:	MIL-DTL-5015 series Mil Spec Circular Connector
Series:	MS3102A box mounting receptacle
Connector Type:	Receptacle
Orientation:	Straight
Contact Type:	Pin Contacts
Number of Contacts:	6 Contacts
Contact Termination:	Solder Cup
Shell sizes:	14S
Contact Arrangement:	14S-6
Coupling Method:	Threaded
Mount Method:	Box Mounting
Mount Feature:	4-Hole Flange
Wire Gauge:	20-16AWG
Durability:	500 Cycles
Alternate Position:	N - Normal
Shielding performance:	Unshielded
Temperature range:	-55°C to + 125°C
Protection degree:	IP67

Materials and Plating

Shell Material:	Aluminum Alloy
Shell Plating:	Olive Drab Cadmium
Contact Material:	Copper Alloy
Contact Plating:	Silver Plating
Insulator Material:	Hard Plastic

Electrical Performance

Rated voltage:	500V
Rated current:	15A
Insulation Resistance:	5,000 Mega ohms minimum (at 25°C)
Contact resistance:	< 10 mΩ

MS3102A Sizes

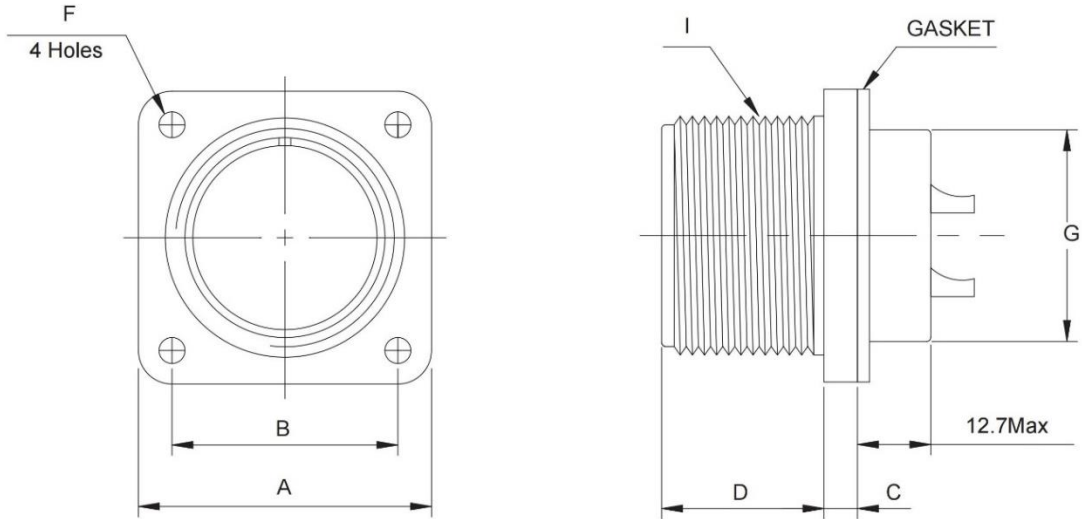

MS3102A box mounting receptacles are used on boxes and equipment cases where no cable support is required.

(mm)

Shell Size	□A ±0.79	□B ±0.12	C ±0.50	D +0.79 -0.00	∅F +0.25 -0.12	∅G Max	I Thread-2A (UNEF)
10SL	25.40	18.26	3.00	14.28	3.05	16.00	5/8-24 NEF
12S	27.80	20.62	3.00	14.28	3.05	16.50	3/4-20 NEF
12	27.80	20.62	3.00	19.05	3.05	16.50	3/4-20 NEF
14S	30.20	23.01	3.00	14.28	3.05	20.00	7/8-20 NEF
14	30.20	23.01	3.00	19.05	3.05	20.00	7/8-20 NEF
16S	32.50	24.61	3.00	14.28	3.05	23.00	1-20 NEF
16	32.50	24.61	3.00	19.05	3.05	23.00	1-20 NEF
18	34.90	26.97	4.00	19.05	3.05	26.00	1 1/8-18 NEF
20	38.10	29.36	4.00	19.05	3.05	29.00	1 1/4-18 NEF
22	41.30	31.75	4.00	19.05	3.05	32.50	1 3/8-18 NEF
24	44.50	34.93	4.00	20.63	3.73	35.50	1 1/2-18 NEF
28	50.80	39.67	4.00	20.63	3.73	42.00	1 3/4-18 NEF
32	57.20	44.45	4.00	22.23	4.39	48.00	2-18 NS
36	63.50	49.23	4.00	22.23	4.39	54.50	2 1/4-16 UN

How to Order

Part Number Example	MS	3102	A	18	-10	P	W	XXX
Connector Type:								
MS - designates Military Standard								
DS - Europe use								
Connector Style								
3100 - wall mounting receptacle								
3101 - cable connecting plug								
3102 - box mounting receptacle								
3106 - straight plug								
3108 - 90° Right angle plug								
Service Class:								
A - General purpose, Solid Endbell								
E - Environmental resisting, with grommet seal & strain relief back shell								
F - Environmental resistance with grommet seal & strain relief back shell, 3106F, and 3108E style include a front 'O' ring seal								
R - Environmental resisting with grommet seal, lightweight and shorter, overall length 310R style includes a front 'O' ring seal								
Shell Size: 10SL/12S/14S/16S/16/18/20/22/24/28/32/36								
Insert Arrangement: (See catalog)								
Contact Types:								
P - designates pin contact, (+) Male								
S - designates socket contact, (-) Female								
Insert Rotation: (See catalog)								
Plating Information:								
No suffix - Olive Drab Zinc								
CD - Cadmium								
C1 - Cobalt (Without +6 Cr)								
621 - Black Zinc								
689 - Electro-less Nickel								
426 - Electro-less Nickel & gold flash contacts								

Learn more about this connector on [Metabee's MIL-DTL-5015 connector catalog](#).