

MIL-DTL-5015 Mil-Spec Connectors

Part Number :

MS3116F8-4P

Client Order no.:

Item no. :

Order no. :

Consignment no. :

Offer no. :

Project :

Remarks :



Basic Information

Product Type:	MIL-DTL-26482 series 1 Mil-Spec Circular Connector
Series:	MS3116 Straight Plug
Connector Type:	Plug
Orientation:	Straight
Contact Type:	Pin Contacts
Number of Contacts:	4 Contacts
Contact Termination:	Solder Cup
Shell sizes:	8
Contact Arrangement:	8-4
Coupling Method:	Bayonet
Mount Method:	Cable Mounting
Mount Feature:	Not Applicable
Wire Gauge:	20/22/24AWG
Durability:	500 Cycles
Alternate Position:	N - Normal
Shielding performance:	Unshielded
Temperature range:	-55°C to + 125°C
Protection degree:	IP67

Materials and Plating

Shell Material:	Aluminum Alloy
Shell Plating:	Olive Drab Cadmium
Contact Material:	Copper Alloy
Contact Plating:	Gold Plating
Insulator Material:	Synthetic Rubber
Grommets and Seals Material:	Synthetic Rubber

Electrical Performance

Rated voltage:	600V
Rated current:	7.5A
Insulation Resistance:	5,000 Mega Ohms minimum (at 25°C)
Contact resistance:	< 10 mΩ

Insert Arrangements for Shell Size 8

Shell Size 8



Insert Number:	8-2	8-3	8-4	8-33
Number of Contacts:	2	3	4	3
Contact Size:	20	20	20	20
Service Rating:	I	I	I	I

MS3116 Class A, E, F, J, P Straight Plug

MS3116 Class A, E, F, J, P
 Straight Plug

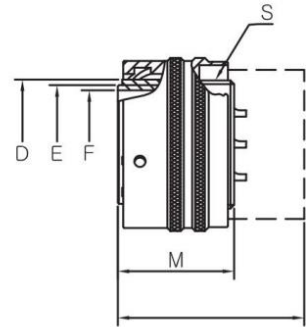
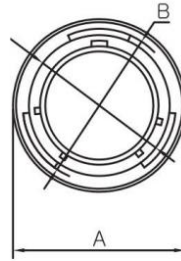

Dimensions in mm

Shell Size	φA max	φB +0.13 ~ -0.15	φC +0.13 ~ -0.03	φD +0.13 ~ -0.15	φE +0.03 ~ -0.13	φF min	M ± 0.13	S THD-2A
8	19.86	14.63	12.22	10.11	9.07	7.42	21.10	7/16-28UNEF
10	23.52	17.70	15.23	13.36	12.32	10.39	21.10	9/16-24UNEF
12	26.49	22.12	19.33	17.14	15.17	13.28	21.10	11/16-24UNEF
14	30.05	25.27	22.48	20.32	18.34	16.46	21.10	13/16-20UNEF
16	33.15	28.45	25.65	23.49	21.52	19.61	21.10	15/16-20UNEF
18	35.33	31.62	28.85	26.03	24.06	21.89	21.10	1 1/16-18UNEF
20	38.89	34.80	32.00	29.21	27.23	25.07	24.90	1 3/16-18UNEF
22	42.06	37.97	35.18	32.39	30.41	28.22	24.90	1 5/16-18UNEF
24	45.13	41.25	38.35	35.56	33.58	31.42	26.40	1 7/16-18UNEF

How to Order

	MS	3112	E	12-	10	P	W	**
Series:	MS							
Shell Style:	3110 – Wall Mounting Receptacle 3111 – Cable Connecting Plug 3112 – Box Mounting Receptacle 3114 – Jam Nut Mounting Receptacle 3115 – Dummy Receptacle 3116 – Straight Plug 3119 – Thru-Bulkhead Receptacle							
Class:	A – General duty, threaded back shell; E – Grommet seal expert on MS3112; F – Grommet seal with strain relief; J – Cable seal with clamp (MS3116 only) P – Potting seal							
Shell Size:	8, 10, 12, 14, 16, 18, 20, 22, 24							
Contact Arrangement:	See Catalog.							
Contact Type:	P – Pin Contact S – Socket Contact C – Feedthrough Contact							
Position:	See Catalog.							
Finish:	No Code – Olive drab cadmium plate finish as standard; F – Electroless Nickel Z3 – Black over Zinc plating (RoHS) A4 – Black over Anodize N – Nickel plating							

Learn more about this connector on [Metabee's MIL-DTL-26482 connector catalog](#).