

## MIL-DTL-5015 Mil-Spec Connectors

**Part Number :**

**MS3116F20-41P**



Client Order no.:

Item no. :

Order no. :

Consignment no. :

Offer no. :

Project :

Remarks :

### Basic Information

<b>Product Type:</b>	MIL-DTL-26482 series 1 Mil-Spec Circular Connector
<b>Series:</b>	MS3116 Straight Plug
<b>Connector Type:</b>	Plug
<b>Orientation:</b>	Straight
<b>Contact Type:</b>	Pin Contacts
<b>Number of Contacts:</b>	41 Contacts
<b>Contact Termination:</b>	Solder Cup
<b>Shell sizes:</b>	20
<b>Contact Arrangement:</b>	20-41
<b>Coupling Method:</b>	Bayonet
<b>Mount Method:</b>	Cable Mounting
<b>Mount Feature:</b>	Not Applicable
<b>Wire Gauge:</b>	20/22/24AWG
<b>Durability:</b>	500 Cycles
<b>Alternate Position:</b>	N - Normal
<b>Shielding performance:</b>	Unshielded
<b>Temperature range:</b>	-55°C to + 125°C
<b>Protection degree:</b>	IP67

### Materials and Plating

<b>Shell Material:</b>	Aluminum Alloy
<b>Shell Plating:</b>	Olive Drab Cadmium
<b>Contact Material:</b>	Copper Alloy
<b>Contact Plating:</b>	Gold Plating
<b>Insulator Material:</b>	Synthetic Rubber
<b>Grommets and Seals Material:</b>	Synthetic Rubber

### Electrical Performance

<b>Rated voltage:</b>	600V
<b>Rated current:</b>	7.5A
<b>Insulation Resistance:</b>	5,000 Mega Ohms minimum (at 25°C)
<b>Contact resistance:</b>	< 10 mΩ

### Insert Arrangements for Shell Size 20

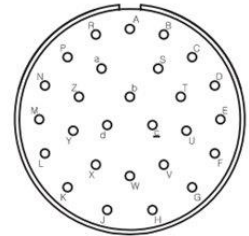
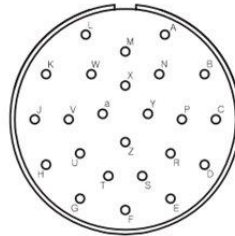
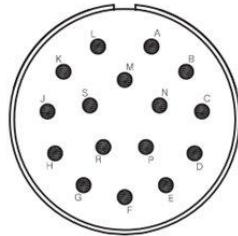

<b>Insert Number:</b>	20-16	20-24	20-27
<b>Number of Contacts:</b>	16	20	27
<b>Contact Size:</b>	16	24	20
<b>Service Rating:</b>	II	I	I

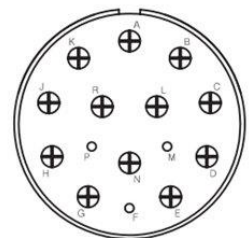
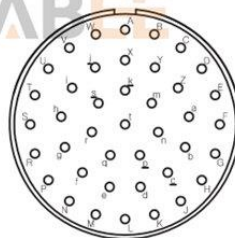
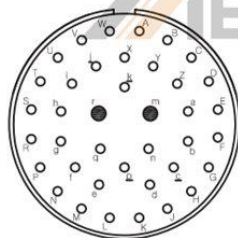

<b>Insert Number:</b>	20-39	20-41	20-90
<b>Number of Contacts:</b>	39	41	15
<b>Contact Size:</b>	37-20, 2-16	20	3-20, 12-12
<b>Service Rating:</b>	II	I	I

## MS3116 Class A, E, F, J, P Straight Plug

MS3116 Class A, E, F, J, P  
 Straight Plug

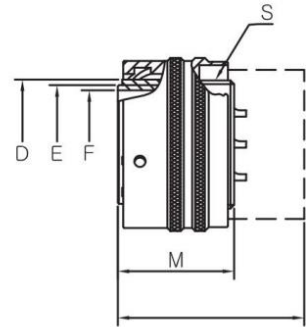
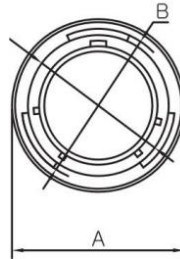

Dimensions in mm

Shell Size	$\varphi A$ max	$\varphi B$ +0.13 ~ -0.15	$\varphi C$ +0.13 ~ -0.03	$\varphi D$ +0.13 ~ -0.15	$\varphi E$ +0.03 ~ -0.13	$\varphi F$ min	M $\pm 0.13$	S THD-2A
8	19.86	14.63	12.22	10.11	9.07	7.42	21.10	7/16-28UNEF
10	23.52	17.70	15.23	13.36	12.32	10.39	21.10	9/16-24UNEF
12	26.49	22.12	19.33	17.14	15.17	13.28	21.10	11/16-24UNEF
14	30.05	25.27	22.48	20.32	18.34	16.46	21.10	13/16-20UNEF
16	33.15	28.45	25.65	23.49	21.52	19.61	21.10	15/16-20UNEF
18	35.33	31.62	28.85	26.03	24.06	21.89	21.10	1 1/16-18UNEF
20	38.89	34.80	32.00	29.21	27.23	25.07	24.90	1 3/16-18UNEF
22	42.06	37.97	35.18	32.39	30.41	28.22	24.90	1 5/16-18UNEF
24	45.13	41.25	38.35	35.56	33.58	31.42	26.40	1 7/16-18UNEF

## How to Order

	<b>MS</b>	<b>3112</b>	<b>E</b>	<b>12-</b>	<b>10</b>	<b>P</b>	<b>W</b>	<b>**</b>
Series:	<b>MS</b>							
Shell Style:	<b>3110</b> – Wall Mounting Receptacle <b>3111</b> – Cable Connecting Plug <b>3112</b> – Box Mounting Receptacle <b>3114</b> – Jam Nut Mounting Receptacle <b>3115</b> – Dummy Receptacle <b>3116</b> – Straight Plug <b>3119</b> – Thru-Bulkhead Receptacle							
Class:	<b>A</b> – General duty, threaded back shell; <b>E</b> – Grommet seal expert on MS3112; <b>F</b> – Grommet seal with strain relief; <b>J</b> – Cable seal with clamp (MS3116 only) <b>P</b> – Potting seal							
Shell Size:	<b>8, 10, 12, 14, 16, 18, 20, 22, 24</b>							
Contact Arrangement:	See Catalog.							
Contact Type:	<b>P</b> – Pin Contact <b>S</b> – Socket Contact <b>C</b> – Feedthrough Contact							
Position:	See Catalog.							
Finish:	<b>No Code</b> – Olive drab cadmium plate finish as standard; <b>F</b> – Electroless Nickel <b>Z3</b> – Black over Zinc plating (RoHS) <b>A4</b> – Black over Anodize <b>N</b> – Nickel plating							

Learn more about this connector on [Metabee's MIL-DTL-26482 connector catalog](#).