

MIL-DTL-5015 Mil-Spec Connectors

Part Number :

MS3106A24-28S



Client Order no.: Item no. :
Order no. : Consignment no. :
Offer no. : Project :
Remarks :

Basic Information

Product Type:	MIL-DTL-5015 series Mil Spec Circular Connector
Series:	MS3106A Straight Plug
Connector Type:	Plug
Orientation:	Straight
Contact Type:	Socket Contacts
Number of Contacts:	24 Contacts
Contact Termination:	Solder Cup
Shell sizes:	24
Contact Arrangement:	24-28
Coupling Method:	Threaded
Mount Method:	Cable Mounting
Mount Feature:	Not Applicable
Wire Gauge:	20-16AWG
Durability:	500 Cycles
Alternate Position:	N - Normal
Shielding performance:	Unshielded
Temperature range:	-55°C to + 125°C
Protection degree:	IP67

Materials and Plating

Shell Material:	Aluminum Alloy
Shell Plating:	Olive Drab Cadmium
Contact Material:	Copper Alloy
Contact Plating:	Silver Plating
Insulator Material:	Hard Plastic

Electrical Performance

Rated voltage:	500V
Rated current:	15A
Insulation Resistance:	5,000 Mega ohms minimum (at 25°C)
Contact resistance:	< 10 mΩ

MS3106A Sizes

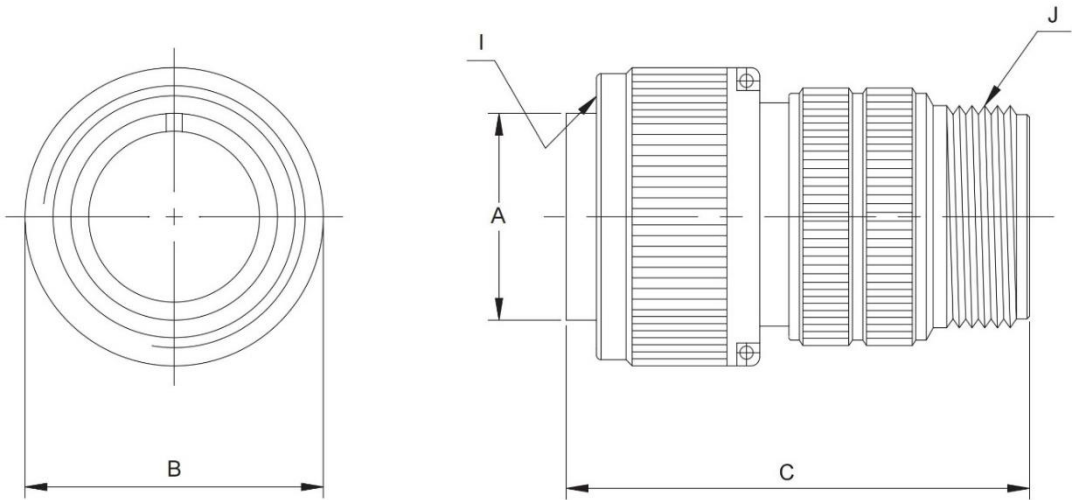

MS3106A straight plugs are used with MS3100, MS3101, and MS3102 receptacles.

(mm)

Shell Size	$\varnothing A$ +0.00 -0.38	$\varnothing B$ Max	C Max	I Thread-2B (UNEF)	J Thread-2A (UNEF)
10SL	11.33	24.61	38.88	5/8-24 NEF	5/8-24 NEF
12S	14.10	26.97	42.87	3/4-20 NEF	5/8-24 NEF
12	14.10	26.97	52.37	3/4-20 NEF	5/8-24 NEF
14S	17.15	29.36	42.87	7/8-20 NEF	3/4-20 NEF
14	17.15	29.36	52.37	7/8-20 NEF	3/4-20 NEF
16S	20.45	31.75	42.87	1-20 NEF	7/8-20 NEF
16	20.45	31.75	52.37	1-20 NEF	7/8-20 NEF
18	23.62	34.13	52.37	1 1/8-18 NEF	1-20 NEF
20	26.67	37.31	55.57	1 1/4-18 NEF	1 3/16-18 NEF
22	29.85	40.48	55.57	1 3/8-18 NEF	1 3/16-18 NEF
24	33.02	43.66	58.72	1 1/2-18 NEF	1 7/16-18 NEF
28	38.61	50.01	58.72	1 3/4-18 NS	1 7/16-18 NEF
32	44.96	56.36	67.92	2-18 NS	1 3/4-18 NS
36	50.29	62.71	67.92	2 1/4-16 UN	2-18 NS

How to Order

Part Number Example	MS	3102	A	18	-10	P	W	XXX
Connector Type:								
MS - designates Military Standard								
DS - Europe use								
Connector Style								
3100 - wall mounting receptacle								
3101 - cable connecting plug								
3102 - box mounting receptacle								
3106 - straight plug								
3108 - 90° Right angle plug								
Service Class:								
A - General purpose, Solid Endbell								
E - Environmental resisting, with grommet seal & strain relief back shell								
F - Environmental resistance with grommet seal & strain relief back shell, 3106F, and 3108E style include a front 'O' ring seal								
R - Environmental resisting with grommet seal, lightweight and shorter, overall length 310R style includes a front 'O' ring seal								
Shell Size: 10SL/12S/14S/16S/16/18/20/22/24/28/32/36								
Insert Arrangement: (See catalog)								
Contact Types:								
P - designates pin contact, (+) Male								
S - designates socket contact, (-) Female								
Insert Rotation: (See catalog)								
Plating Information:								
No suffix - Olive Drab Zinc								
CD - Cadmium								
C1 - Cobalt (Without +6 Cr)								
621 - Black Zinc								
689 - Electro-less Nickel								
426 - Electro-less Nickel & gold flash contacts								

Learn more about this connector on [Metabee's MIL-DTL-5015 connector catalog](#).