

# HR10A Series Miniature Camera Connectors

## 1. Main Features

- Push-pull coupling mechanism assures easy and quick connecting & disconnecting.
- Smart design, well-balanced, simplified layout in the limited space.
- Straight solder contacts, PCB contacts.
- Five-key system permits only one way of coupling when blind mating.
- Series of multi-core, high-density installation space-saving.
- Easy wiring and mounting, no use of screws make wiring and mounting easier.

## 2. Part Numbering System

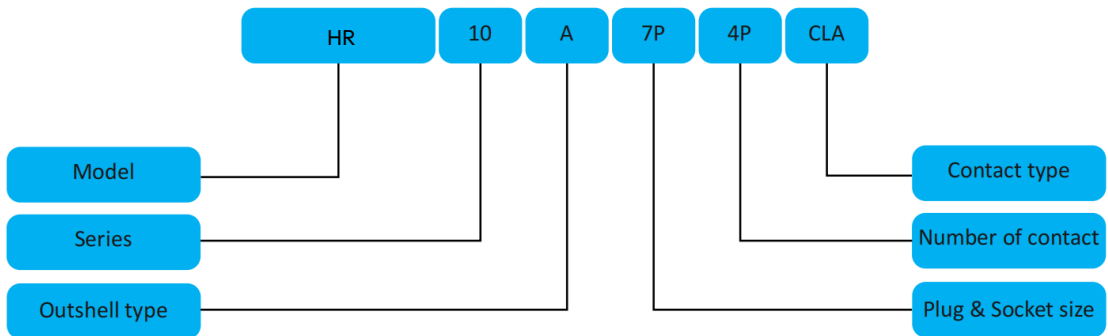

## 3. Technical Characteristics

No.	Specification	Out Shell Size		01		02		
		Pin Array	4	6	7	7	10	12
1	Contact Diameter (mm)		0.6		0.8		0.6	
2	Contact Resistance (mΩ)		10		6.5		10	
3	Working Voltage (KV/DC)		0.3		0.45		0.3	
	Working Voltage (KV/AC)		0.2		0.35		0.2	
4	Experimental Voltage (KV/DV)		0.9		1.2		0.9	
	Experimental Voltage (KV/AV)		0.5		0.8		0.5	
5	Working Current (A)		2		3.5		2	
6	Work temperature (OC)		-400C ~ 1250C					
7	Lifetime		1000 mes					

## 4. Product Size

### 4.1 Fixed Receptacle with Solder Pin

						
Size	Item NO.	Pin Array	A	B	C	D
01	HR10A-7R-4S-CLL	4	14	11	8.85	M8*0.5
	HR10A-7R-6S-CLL	6	14	11	8.85	M8*0.5
	HR10A-7R-7S-CLL	7	14	11	8.85	M8*0.5
02	HR10A-10P-7S-CLL	7	16	14	11.9	M11*0.75
	HR10A-10P-10S-CLL	10	16	14	11.9	M11*0.75
	HR10A-10P-12S-CLL	12	16	14	11.9	M11*0.75

### 4.2 Fixed Receptacle with PCB Pin

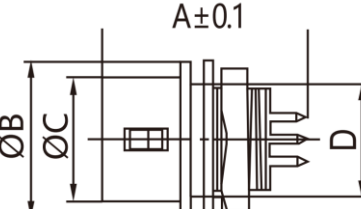
						
Size	Item NO.	Pin Array	A	B	C	D
01	HR10A-7R-4S-CLN	4	15.5	11	8.85	M8*0.5
	HR10A-7R-6S-CLN	6	15.5	11	8.85	M8*0.5
	HR10A-7R-7S-CLN	7	15.5	11	8.85	M8*0.5
02	HR10A-10P-7S-CLN	7	15.5	14	11.9	M11*0.75
	HR10A-10P-10S-CLN	10	15.5	14	11.9	M11*0.75
	HR10A-10P-12S-CLN	12	15.5	14	11.9	M11*0.75

### 4.3 Plug with Solder Pin

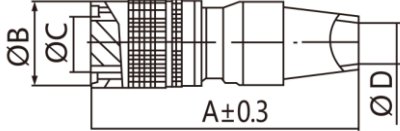
						
Size	Item NO.	Pin Array	A	B	C	D
01	HR10A-7P-4P-CLA	4	35.5	11	8.85	5
	HR10A-7P-6P-CLA	6	35.5	11	8.85	5
	HR10A-7P-7P-CLA	7	35.5	11	8.85	5
02	HR10A-10P-7P-CLA	7	44	14	11.9	7
	HR10A-10P-10P-CLA	10	44	14	11.9	7
	HR10A-10P-12P-CLA	12	44	14	11.9	7

### 4.4 Free Receptacle with Solder Pin

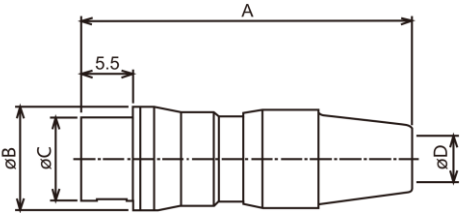
						
Size	Item NO.	Pin Array	A	B	C	D
01	HR10A-7J-4S-CLL	4	35.5	11	8.85	5
	HR10A-7J-6S-CLL	6	35.5	11	8.85	5
	HR10A-7J-7S-CLL	7	35.5	11	8.85	5
02	HR10A-10J-7S-CLL	7	44	14	11.9	7
	HR10A-10J-10S-CLL	10	44	14	11.9	7
	HR10A-10J-12S-CLL	12	44	14	11.9	7

## 5. Panel Holes Dimension for Fixed Receptacle

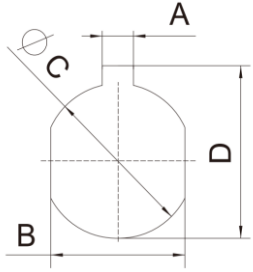
	Drawing			
	Size	A	B	C
01	1.6	7.3	8.1	9.0
02	2.5	10.1	11.1	12

## 6. PCB Drilling Pattern

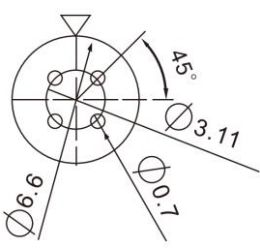
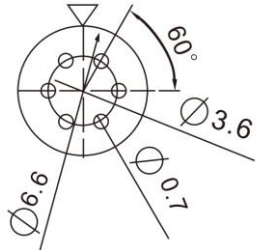
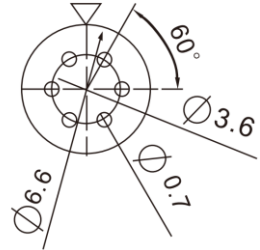
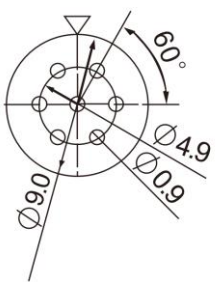
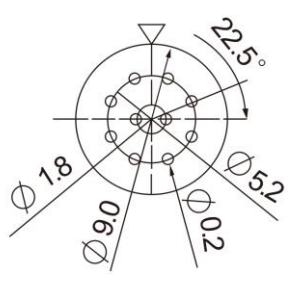
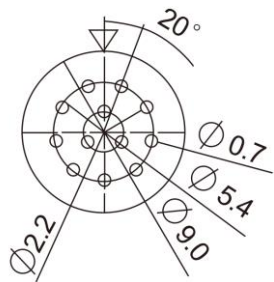
Size	Pin Array		
01			
	04	06	07
02			
	07	10	12