



MIL-DTL-5015
(formally MIL-C-5015)
Series Mil-Spec
Circular Connectors
Catalog

MIL-DTL-5015 (formally MIL-C-5015) Series Mil-Spec Circular Connectors

1. Introduction

Metabee's MIL-DTL-5015 (formerly MIL-C-5015) series mil-spec circular connectors meet the performance requirements of the MIL-DTL-5015 (now SAE-SA50151). To ensure that our customers receive high-quality connectors, we use only the best materials, precision production, and strict quality control procedures.

These MIL-DTL-5015 connectors have green and black zinc alloy plating, which is environmentally safe. The black zinc plating is RoHS compliant. We have redesigned the contacts to ensure that the solder cups remain in the correct orientation and do not twist during wiring termination. The contacts are machined for strength and longevity and are silver-plated.



2. Features:

- Threaded coupling
- High-strength aluminum alloy connector;
- High-strength plastic insulators;
- Environmentally safe shell finishes;
- Protected against corrosion;
- IP67 rating;
- High-quality plating finish;
- Machined contacts;
- Competitive prices.

3. Applications:

- Military & Defense
- Aerospace & Space
- Railway & Mass Transit
- Industrial & Heavy Equipment
- Alternative Energy, Nuclear, Oil & Gas

4. Key Specifications:

Basic Information:

Product Type:	MIL-DTL-5015 series Mil Spec Circular Connector
Series:	MS3100A/MS3101A/MS3102A/MS3106A/MS3108A
Number of Positions:	1-37 Pin
Shell sizes:	10SL/12S/14S/16S/16/18/20/22/24/28/32/36
Contact Type:	Pin Contacts / Socket Contacts
Orientation:	Straight / Right Angle
Durability:	500 cycles
Contact Sizes:	0AWG, 4AWG, 8AWG, 12AWG, 16AWG
Coupling Method:	Threaded
Temperature range:	-55°C ~ + 125°C
Protection degree:	IP67

Materials and Plating:

Shell Material:	Aluminum Alloy
Shell Plating:	green and black zinc alloy plating
Contact Material:	Copper Alloy
Contact Plating:	Silver
Insulator Material:	PPS Plastic / Silicone Rubber

Electrical Performance:

Rated voltage:	500V (Normal temperature), 250V (High temperature)
Rated current:	13A for 16AWG/23A for 12AWG/46A for 8AWG/80A for 4AWG/150A for 0AWG
Insulation Resistance:	5,000 Mega ohms minimum (at 25°C)
Contact resistance:	< 10 mΩ

5. Basic Construction

MIL-DTL-5015 connectors meet the latest performance requirements of MIL-DTL-5015 (now SAE-SA50151).

These connectors represent well-proven electrical capability at an acceptable cost for most equipment where durability is important. MIL-DTL-5015 features threaded coupling & single key & keyway polarization representing maximum simplicity in design. Applications include industrial machines, military ground support equipment, ordnance & shipboard installation. MIL-DTL-5015 connectors are available in classes A, B, E/F, R, and also offer a range of pre-earth connectors.

Therefore, you will always find the right connector in Metabee, with us, for conditions & performance requirements you may have.



5.1 Dielectric with standing voltage

Service rating	Test voltage AC(rms)	Operating voltage	
		AC	DC
Inst	1,000	200	250
A	2,000	500	700
D	2,800	900	1,250
E	3,500	1,250	1,750
B	4,500	1,750	2,450
C	7,000	3,000	4,200

5.2 Contact engagement and separation forces

Contact mating end size	Minimum separation force(ounce)	Maximum average engagement force (ounce)	Maximum average engagement force (ounce)
#16	2	24	30
#12	3	24	30
#8	5	-	160
#4	10	-	240
#0	15	-	320

5.3 Electrical data

Contact size	Pin contact Diam,	Solder Pot Diam,	Rated Current (Mated with insulators)	Contact resistance	
				Test current DC A	Potential Drop(Max) mV
#16	1.6	1.9	13A	13A	49
#12	2.4	3.0	23A	23A	42
#8	3.6	5.4	46A	46A	26
#4	5.7	8.4	80A	80A	23
#0	9.1	12.2	150A	150A	21

5.4 Wire range accommodations

Size	A.W.G	Wire normal square size(mm ²)	Dielectric material outer diam.
#16	#22~#16	≤1.3	1.7~3.3
#12	#14~#12	≤3.5	2.9~4.3
#8	#10~#8	≤8.0	4.2~6.4
#4	#6~#4	≤22.0	7.0~9.4
#0	#2~#0	≤50.0	10.6~14.0

6. Series Overview



Wall Mounting Receptacle



Cable connecting Receptacle



Box Mounting Receptacle



Straight Plug



Right Angle Plug

MS3100A wall mounting receptacles are used to carry wires through walls or bulkheads or to provide the means of disconnection at a bulkhead. MS3100A receptacles mate with MS3106A and MS3108A plugs.

MS 3101A cable connecting receptacles are used for cable extension requirements where mounting provisions are unnecessary. MS3101A plugs mate with MS3106A and MS3108A connectors.

MS3102A box mounted receptacles are used in junction boxes or as an integral part of equipment. MS3102A receptacles will mate with MS3106A and MS3108A plugs.

MS3106A straight plug utilizes a solid endbell. The MS 3106A mates with MS3100, MS3101, and MS3102 connectors

MS3108A 90° right angle plugs are used where there is limited space and where wires must be brought at abrupt angles. This plug will mate with MS3100, MS3101, and MS3102 connectors.

7. How to Order

MIL-DTL-5015 (Solder Contacts)

Part Number Example	MS	3102	A	18	-10	P	W	XXX
Connector Type:								
MS - designates Military Standard								
DS - Europe use								
Connector Style								
3100 - wall mounting receptacle								
3101 - cable connecting plug								
3102 - box mounting receptacle								
3106 - straight plug								
3108 - 90° Right angle plug								
Service Class:								
A - General purpose, Solid Endbell								
E - Environmental resisting, with grommet seal & strain relief back shell								
F - Environmental resistance with grommet seal & strain relief back shell, 3106F, and 3108E style include a front 'O' ring seal								
R - Environmental resisting with grommet seal, lightweight and shorter, overall length 310R style includes a front 'O' ring seal								
Shell Size: (See table, pages 15-16)								
Insert Arrangement: (See table, pages 15-16)								
Contact Types:								
P - designates pin contact, (+) Male								
S - designates socket contact, (-) Female								
Insert Rotation: (See table, pages 15-16)								
Plating Information:								
No suffix - Olive Drab Zinc								
CD - Cadmium								
C1 - Cobalt (Without +6 Cr)								
621 - Black Zinc								
689 - Electro-less Nickel								
426 - Electro-less Nickel & gold flash contacts								

MIL-DTL-5015 (Crimp Contacts)

Part Number Example	MS	4102	A	18	-10	P	W	XXX
Connector Type:								
MS - designates Military Standard								
Connector Style								
4100 - wall mounting receptacle								
4101 - cable connecting plug								
4102 - box mounting receptacle								
4106 - straight plug								
4108 - 90° Right angle plug								
Service Class:								
A - General purpose, Solid Endbell								
E - Environmental resisting, with grommet seal & strain relief back shell								
F - Environmental resistance with grommet seal & strain relief back shell, 3106F, and 3108E style include a front 'O' ring seal								
R - Environmental resisting with grommet seal, lightweight and shorter, overall length 310R style includes a front 'O' ring seal								
Shell Size: (See table, pages 15-16)								
Insert Arrangement: (See table, pages 15-16)								
Contact Types:								
P - designates pin contact, (+) Male								
S - designates socket contact, (-) Female								
Insert Rotation: (See table, pages 15-16)								
Plating Information:								
No suffix - Olive Drab Zinc								
CD - Cadmium								
C1 - Cobalt (Without +6 Cr)								
621 - Black Zinc								
689 - Electro-less Nickel								
426 - Electro-less Nickel & gold flash contacts								

7. Connector Size

MS3100A - Wall Mounting Receptacle

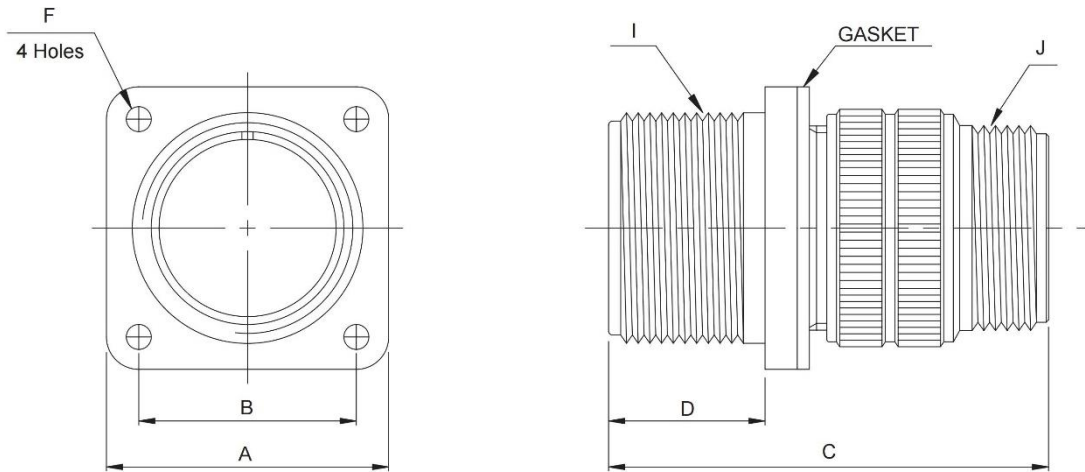

MS3100A wall mounting receptacles are used with the MS3057 cable clamp or with conduit to eliminate need for the conduit box in applications where wires are carried thru walls or bulkheads.

(mm)

Shell Size	□A ±0.79	□B ±0.12	C Max	D +0.79 -0.00	∅F +0.25 -0.12	I Thread-2A (UNEF)	J Thread-2A (UNEF)
10SL	25.40	18.26	38.88	14.28	3.20	5/8-24 NEF	5/8-24 NEF
12S	27.79	20.62	42.87	14.28	3.20	3/4-20 NEF	5/8-24 NEF
12	27.79	20.62	52.37	19.05	3.20	3/4-20 NEF	5/8-24 NEF
14S	30.18	23.01	42.87	14.28	3.20	7/8-20 NEF	3/4-20 NEF
14	30.18	23.01	52.37	19.05	3.20	7/8-20 NEF	3/4-20 NEF
16S	32.54	24.61	42.87	14.28	3.20	1-20 NEF	7/8-20 NEF
16	32.54	24.61	52.37	19.05	3.20	1-20 NEF	7/8-20 NEF
18	34.93	26.97	52.37	19.05	3.20	1 1/8-18 NEF	1-20 NEF
20	38.10	29.36	55.57	19.05	3.20	1 1/4-18 NEF	1 3/16-18 NEF
22	41.28	31.75	55.57	19.05	3.20	1 3/8-18 NEF	1 3/16-18 NEF
24	44.45	34.93	58.72	20.63	3.73	1 1/2-18 NEF	1 7/16-18 NEF
28	50.80	39.67	58.72	20.63	3.73	1 3/4-18 NS	1 7/16-18 NEF
32	57.15	44.45	67.92	22.23	4.39	2-18 NS	1 3/4-18 NS
36	63.50	49.23	67.92	22.23	4.39	2 1/4-16 UN	2-18 NS

MS3101A - Cable Mounting Receptacle

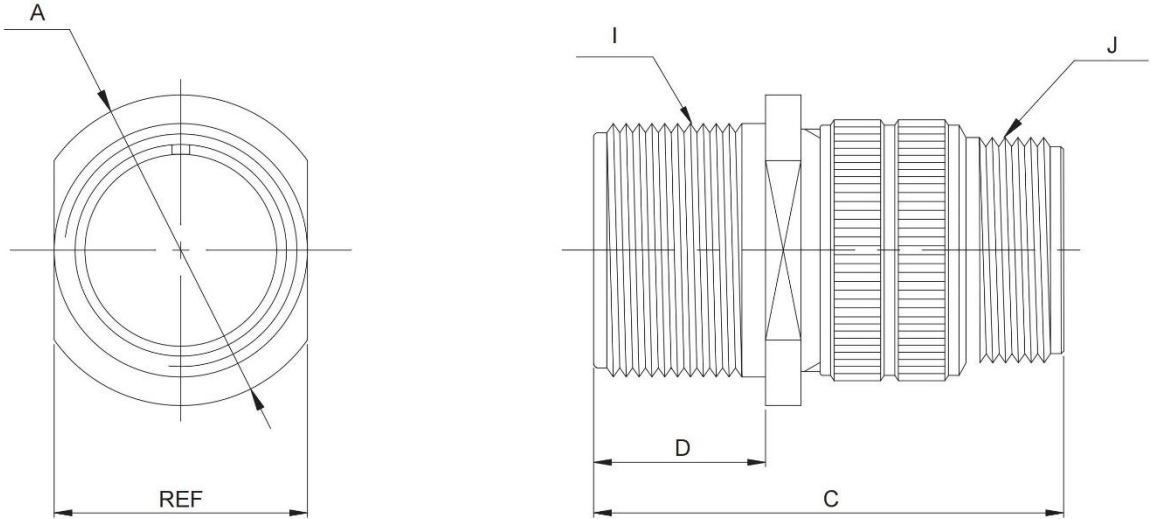

MS3101A solid endbell cable connecting receptacles are used for cable extension requirements where mounting provisions are unnecessary.

(mm)

Shell Size	∅ A Max	C Max	D +0.79 -0.00	I Thread-2A (UNEF)	J Thread-2A (UNEF)
10SL	24.61	38.88	14.28	5/8-24 NEF	5/8-24 NEF
12S	26.97	42.87	14.28	3/4-20 NEF	5/8-24 NEF
12	26.97	52.37	19.05	3/4-20 NEF	5/8-24 NEF
14S	29.36	42.87	14.28	7/8-20 NEF	3/4-20 NEF
14	29.36	52.37	19.05	7/8-20 NEF	3/4-20 NEF
16S	31.75	42.87	14.28	1-20 NEF	7/8-20 NEF
16	31.75	52.37	19.05	1-20 NEF	7/8-20 NEF
18	34.13	52.37	19.05	1 1/8-18 NEF	1-20 NEF
20	37.31	55.57	19.05	1 1/4-18 NEF	1 3/16-18 NEF
22	40.48	55.57	19.05	1 3/8-18 NEF	1 3/16-18 NEF
24	43.66	58.72	20.63	1 1/2-18 NEF	1 7/16-18 NEF
28	50.01	58.72	20.63	1 3/4-18 NS	1 7/16-18 NEF
32	56.36	67.92	22.23	2-18 NS	1 3/4-18 NS
36	62.71	67.92	22.23	2 1/4-16 UN	2-18 NS

MS3102A - Box Mounting Receptacle

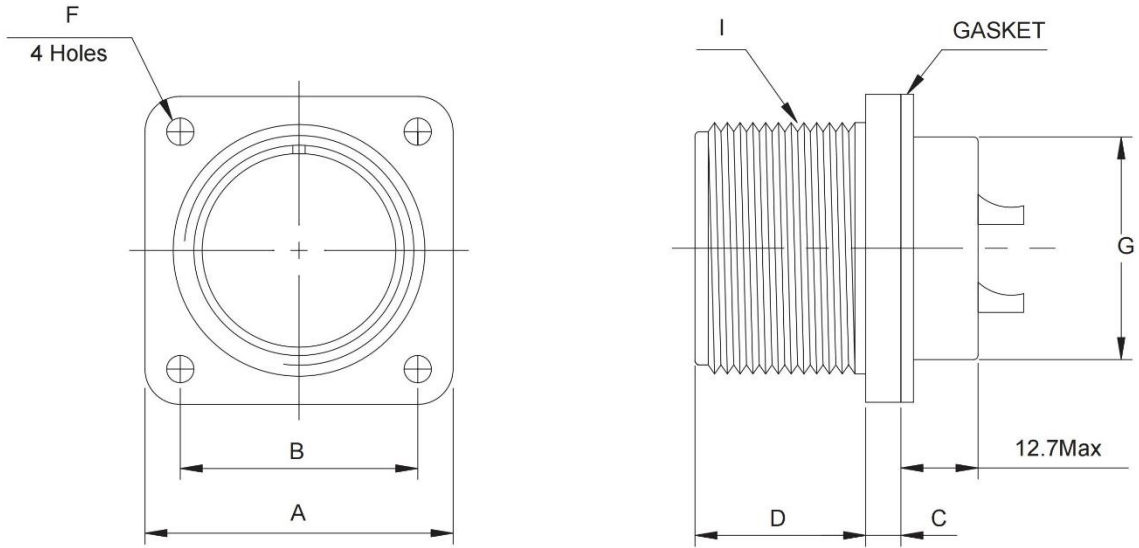

MS3102A box mounting receptacles are used on boxes and equipment cases where no cable support is required.

(mm)

Shell Size	□A ±0.79	□B ±0.12	C ±0.50	D +0.79 -0.00	∅F +0.25 -0.12	∅G Max	I Thread-2A (UNEF)
10SL	25.40	18.26	3.00	14.28	3.05	16.00	5/8-24 NEF
12S	27.80	20.62	3.00	14.28	3.05	16.50	3/4-20 NEF
12	27.80	20.62	3.00	19.05	3.05	16.50	3/4-20 NEF
14S	30.20	23.01	3.00	14.28	3.05	20.00	7/8-20 NEF
14	30.20	23.01	3.00	19.05	3.05	20.00	7/8-20 NEF
16S	32.50	24.61	3.00	14.28	3.05	23.00	1-20 NEF
16	32.50	24.61	3.00	19.05	3.05	23.00	1-20 NEF
18	34.90	26.97	4.00	19.05	3.05	26.00	1 1/8-18 NEF
20	38.10	29.36	4.00	19.05	3.05	29.00	1 1/4-18 NEF
22	41.30	31.75	4.00	19.05	3.05	32.50	1 3/8-18 NEF
24	44.50	34.93	4.00	20.63	3.73	35.50	1 1/2-18 NEF
28	50.80	39.67	4.00	20.63	3.73	42.00	1 3/4-18 NEF
32	57.20	44.45	4.00	22.23	4.39	48.00	2-18 NS
36	63.50	49.23	4.00	22.23	4.39	54.50	2 1/4-16 UN

MS3106A – Straight Plug

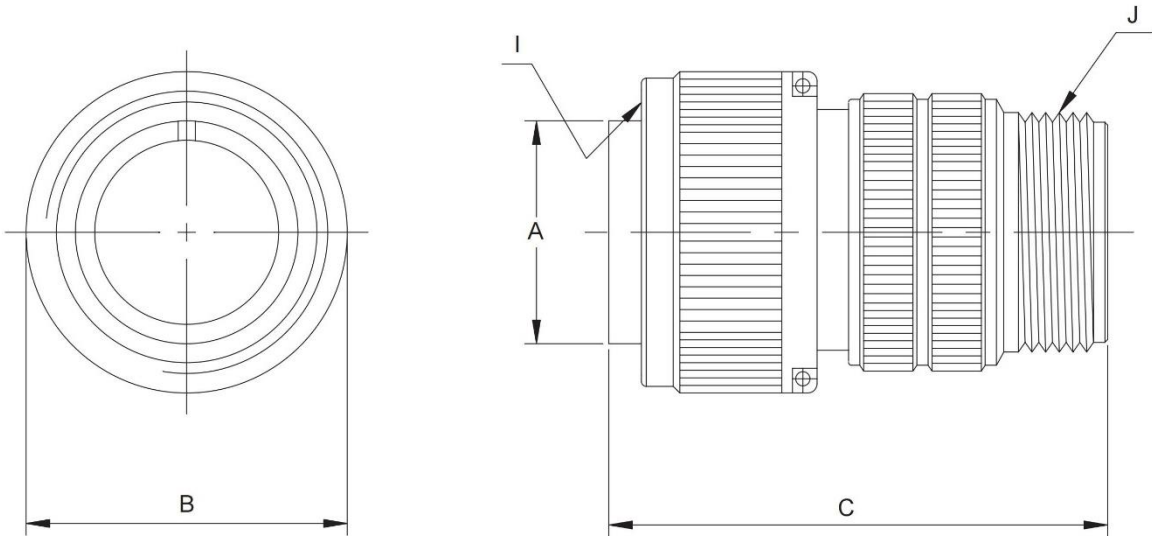

MS3106A straight plugs are used with 3100, 3101 and 3102 receptacles.

(mm)

Shell Size	Ø A +0.00 -0.38	Ø B Max	C Max	I Thread-2B (UNEF)	J Thread-2A (UNEF)
10SL	11.33	24.61	38.88	5/8-24 NEF	5/8-24 NEF
12S	14.10	26.97	42.87	3/4-20 NEF	5/8-24 NEF
12	14.10	26.97	52.37	3/4-20 NEF	5/8-24 NEF
14S	17.15	29.36	42.87	7/8-20 NEF	3/4-20 NEF
14	17.15	29.36	52.37	7/8-20 NEF	3/4-20 NEF
16S	20.45	31.75	42.87	1-20 NEF	7/8-20 NEF
16	20.45	31.75	52.37	1-20 NEF	7/8-20 NEF
18	23.62	34.13	52.37	1 1/8-18 NEF	1-20 NEF
20	26.67	37.31	55.57	1 1/4-18 NEF	1 3/16-18 NEF
22	29.85	40.48	55.57	1 3/8-18 NEF	1 3/16-18 NEF
24	33.02	43.66	58.72	1 1/2-18 NEF	1 7/16-18 NEF
28	38.61	50.01	58.72	1 3/4-18 NS	1 7/16-18 NEF
32	44.96	56.36	67.92	2-18 NS	1 3/4-18 NS
36	50.29	62.71	67.92	2 1/4-16 UN	2-18 NS

MS3108A – Right Angle Plug

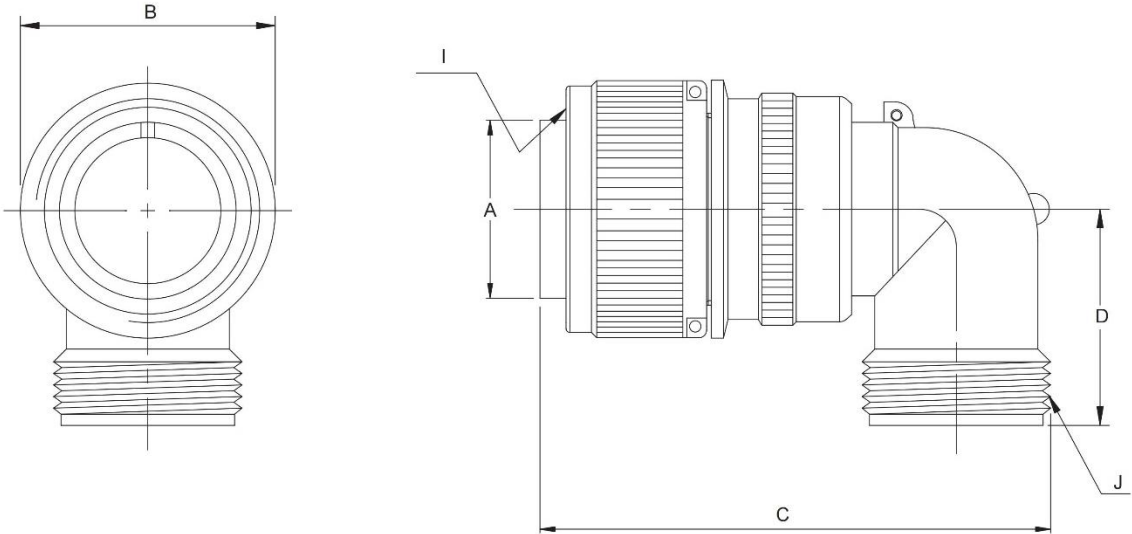

MS3108A Right Angle plugs, have a solid endbell and are used where wire must be brought at an abrupt angle. Either the split or solid endbells on the 3108 are capable of being rotated and locked.

(mm)

Shell Size	$\varnothing A$ +0.00 -0.38	$\varnothing B$ Max	C Max	D Max	I Thread-2B (UNEF)	J Thread-2A (UNEF)
10SL	11.33	24.61	46.02	25.40	5/8-24 NEF	5/8-24 NEF
12S*	14.10	26.97	50.80	26.90	3/4-20 NEF	5/8-24 NEF
12	14.10	26.97	57.15	26.90	3/4-20 NEF	5/8-24 NEF
14S	17.15	29.36	53.97	28.50	7/8-20 NEF	3/4-20 NEF
14	17.15	29.36	58.72	28.50	7/8-20 NEF	3/4-20 NEF
16S	20.45	31.75	60.32	30.10	1-20 NEF	7/8-20 NEF
16	20.45	31.75	65.07	30.10	1-20 NEF	7/8-20 NEF
18	23.62	34.13	68.27	33.30	1 1/8-18 NEF	1-20 NEF
20	26.67	37.71	76.98	34.90	1 1/4-18 NEF	1 3/16-18 NEF
22	29.85	40.48	76.98	34.90	1 3/8-18 NEF	1 3/16-18 NEF
24	33.02	43.66	86.51	39.60	1 1/2-18 NEF	1 7/16-18 NEF
28	38.61	50.01	86.51	39.60	1 3/4-18 NS	1 7/16-18 NEF
32	44.96	56.36	95.25	47.60	2-18 NS	1 3/4-18 NS
36	50.29	62.71	100.02	52.30	2 1/4-16 UN	2-18 NS

* No Tooling

7. Insert Arrangements and Alternate Positioning

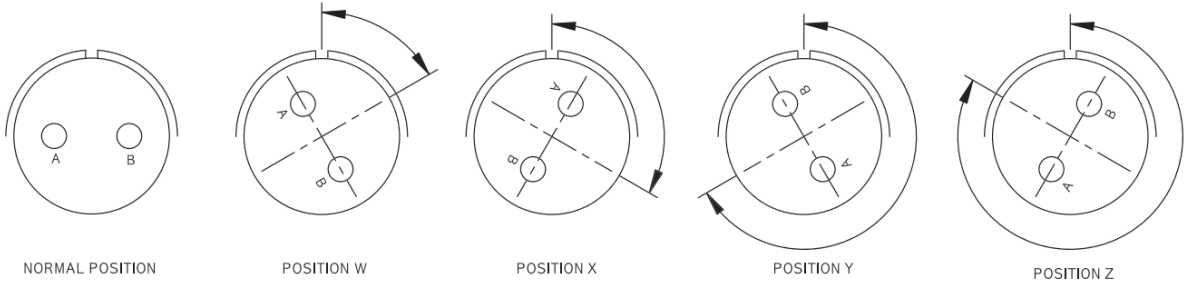

Contact Arrangement	Service Rating	Total Contacts	Contact Size					Alternate Position-Degrees				
			0	4	8	12	16	W	X	Y	Z	
10SL-2	A	1					1	-	-	-	-	
10SL-3	A	3					3	-	-	-	-	
10SL-4	A	2					2	63	-	-	-	
12S-1	A	2					2	-	-	-	-	
12S-3	A	2					2	70	145	215	290	
12S-5	D	1			1			-	-	-	-	
14S-1	A	3					3	-	-	-	-	
14S-2	Inst	4					4	-	120	240	-	
14S-5	Inst	5					5	-	110	-	-	
14S-6	Inst	6					6	-	-	-	-	
14S-7	A	3					3	90	180	270	-	
14S-9	A	2					2	70	145	215	290	
14S-07	A	7					7	-	-	-	-	
16S-1	A	7					7	80	-	-	280	
16S-4	D	2					2	35	110	250	325	
16S-5	A	3					3	70	145	215	290	
16S-8	A	5					5	-	170	265	-	
16-9	A	4				2	2	35	110	250	325	
16-10	A	3					3	90	180	270	-	
16-11	A	2					2	35	110	250	325	
16-12	A	1		1				-	-	-	-	
16-13	A	2					2	35	110	250	325	
18-1	A/Inst	10					10	70	145	215	290	
18-3	D	2					2	35	110	250	325	
18-4	D	4					4	35	110	250	325	
18-5	D	3					2	1	80	110	250	280
18-8	A	8					1	7	70	-	290	
18-9	Inst.	7					2	5	80	110	250	280
18-10	A	4					4	-	120	240	-	
18-11	A	5					5	-	170	265	-	
18-12	A	6					6	80	-	-	280	
18-13	A	4			1	3		80	110	250	280	
18-15	A	4					4	-	120	240	-	

Contact Arrangement	Service Rating	Total Contacts	Contact Size					Alternate Position-Degrees				
			0	4	8	12	16	W	X	Y	Z	
18-19	A	10					10	-	120	240	-	
18-20	A	5					5	90	180	270	-	
18-21	A	3					3	-	-	-	-	
18-22	D	3					3	70	145	215	290	
18-32	A	8					8	-	-	-	-	
20-2	D	1	1					-	-	-	-	
20-3	D	3					3	40	145	215	290	
20-4	D	4					4	45	110	250	-	
20-7	D/A	8					8	80	110	250	280	
20-8	Inst.	6					2	4	80	110	250	280
20-11	Inst.	13					13	-	-	-	-	
20-15	A	7					7	80	-	-	280	
20-16	A	9					2	7	80	110	250	280
20-17	A	6					5	1	90	180	270	-
20-18	A	9					3	6	35	110	250	325
20-19	A	3					3	90	180	270	-	
20-22	A	6					3	3	80	110	250	280
20-23	A	2					2	35	110	250	325	
20-27	A	14					14	35	110	250	325	
20-29	A	17					17	80	-	-	20	
20-33	A	11					11	-	-	-	-	
20-01	A	10					10	-	-	-	-	
22-1	D	2					2	35	110	250	325	
22-2	D	3					3	70	145	215	290	
22-4	A	4					2	2	35	110	250	325
22-7	E	1	1					-	-	-	-	
22-8	E	2					2	35	110	250	325	
22-9	E	3					3	70	145	215	290	
22-10	E	4					4	35	110	250	325	
22-11	B	2					2	35	110	250	325	
22-12	D	5					2	3	80	110	250	280
22-13	D/A	5					4	1	34	110	250	325
22-14	A	19					19	80	110	250	280	

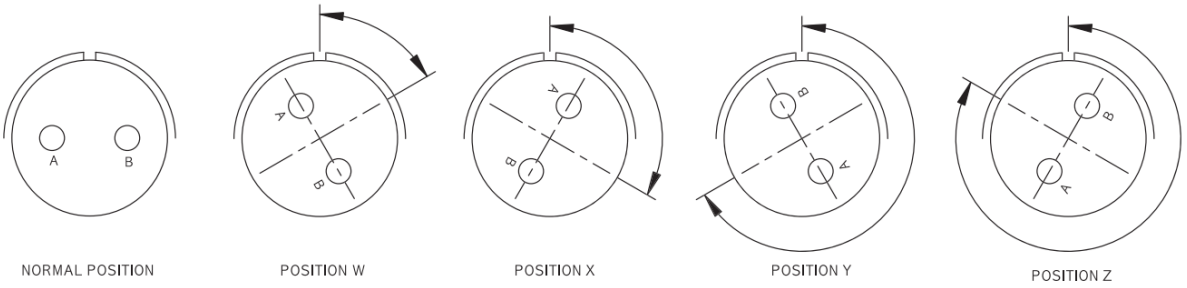

Contact Arrangement	Service Rating	Total Contacts	Contact Size					Alternate Position-Degrees			
			0	4	8	12	16	W	X	Y	Z
22-15	E/A	6				5	1	80	110	250	280
22-18	A/D	8					8	80	110	250	280
22-19	A	14					14	80	110	250	280
22-20	A	9					9	35	110	250	325
22-21	A	3	1				2	-	-	-	-
22-22	A	4			4			-	110	250	-
22-23	D/A	8			8		35	-	250	-	-
22-27	D/A	9			1		8	80	-	250	280
22-28	A	7				7		80	-	-	280
24-2	D	7				7		80	-	-	28
24-5	A	16					16	80	110	250	280
24-6	D/A	8				8		80	110	250	280
24-7	A	16				2	14	80	110	250	280
24-9	A	2		2				35	110	250	325
24-10	A	7			7			80	-	-	280
24-11	A	9			3	6		35	110	250	32
24-12	A	5		2		3		80	110	250	280
24-20	D	11				2	9	80	110	250	280
24-22	D	4			4			45	110	250	-
24-28	Inst	24					24	80	110	250	280
24-02	A	9				9		-	-	-	-
24-03	A	12					12	-	-	-	-
28-1	D/A	9			3	6		80	110	250	280
28-3	E	3			3			70	145	215	290
28-6	D	3		3				70	145	215	290
28-7	D	2		2				35	110	250	325
28-9	D	12				6	6	80	110	250	280
28-10	D/A	7		2	2	3		80	110	250	280
28-11	A	22				4	18	80	110	250	280
28-12	A	26					26	90	180	270	-
28-15	A	35					35	80	110	250	280
28-16	A	20					20	80	110	250	280
28-17	B/D/A	15					15	-	-	-	-

Contact Arrangement	Service Rating	Total Contacts	Contact Size					Alternate Position-Degrees				
			0	4	8	12	16	W	X	Y	Z	
28-18	A	12					12	-	-	-	-	
28-19	B/D/A	10				4	6	80	110	250	280	
28-20	A	14					10	4	80	110	250	280
28-21	A	37						37	80	110	250	280
28-22	D	6			3			3	70	145	215	290
28-05	A	5				5			-	-	-	-
28-51	A	12					12		-	-	-	-
32-1	E/D	5	2				3		80	110	250	280
32-5	D	2	2						35	110	250	325
32-6	A	23		2	3	2	16	80	110	250	325	
32-7	INST/A	35				7	28	80	125	235	280	
32-8	A	30					6	24	80	125	235	280
32-9	D	14		2				12	80	110	250	280
32-15	D	8	2				6		35	110	250	280
32-17	D	4		4					45	110	250	280
32-22	A	54						54	80	110	250	280
32-03	A	3		3					-	-	-	-
32-59	A	42			2			40	-	-	-	-
36-1	D	22				4	18	80	110	250	280	
36-3	D	6	3				3		70	145	215	290
36-4	D/A	3	3						70	145	215	290
36-5	A	4	4						-	120	240	-
36-7	A	47				7	40	80	110	250	280	
36-8	A	47				1	46	80	110	250	280	
36-9	A	31		1	2	14	14	80	125	235	280	
36-10	A	48						48	80	125	235	280
36-15	D/A	35						35	60	125	245	305
36-30	A	30					30		-	-	-	-
36-40	A	40					22	18	-	-	-	-
36-52	A	52						52	72	144	216	288
36-02	A	27					27		-	-	-	-
36-03	A	20					20		-	-	-	-
36-04	A	22					22		-	-	-	-

8. Contact Arrangement

Front face of pin insert or rear face of socket insert illustrated

		Front of Socket Insert	Front of Socket Insert				
Insert Arrangement	10SL-2	10SL-3	10SL-4	12S-1	12S-3	12S-5	14S-1
Service Rating	A	A	A	A	A	D	A
Number of Contacts	1	3	2	2	2	1	3
Contact Size	16	16	16	16	16	12	16

Insert Arrangement	14S-2	14S-5	14S-6	14S-7	14S-9	14S-07	16S-1
Service Rating	Inst.	Inst.	Inst.	A	A	A	A
Number of Contacts	4	5	6	3	2	7	7
Contact Size	16	16	16	16	16	16	16

Insert Arrangement	16S-4	16S-5	16S-8	16-9	16-10	16-11
Service Rating	D	A	A	A	A	A
Number of Contacts	2	3	5	2 2	3	2
Contact Size	16	16	16	12 16	12	12



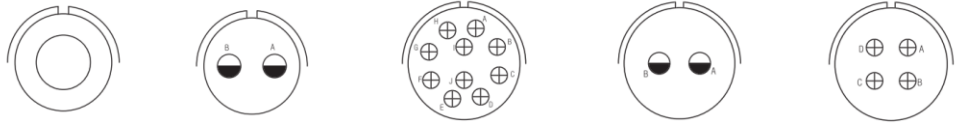

Insert Arrangement	16-12	16-13	18-1	18-3	18-4
Service Rating	A	A	B, C, F, G=A; Bal.=Inst	D	D
Number of Contacts	1	2	10	2	4
Contact Size	4	12	16	12	16

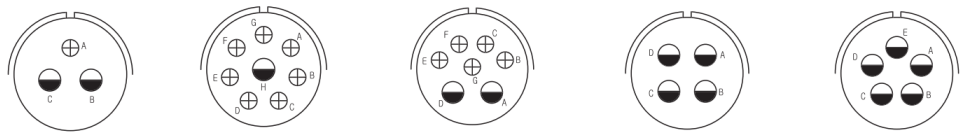

Insert Arrangement	18-5	18-8	18-9	18-10	18-11
Service Rating	D	A	Inst.	A	A
Number of Contacts	2 1	1 7	2 5	4	5
Contact Size	12 16	12 16	12 16	12	12

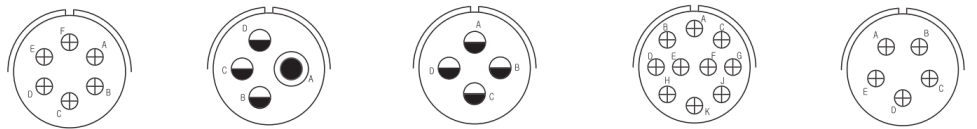

Insert Arrangement	18-12	18-13	18-15	18-19	18-20
Service Rating	A	A	A	A	A
Number of Contacts	6	1 3	4	10	5
Contact Size	16	8 12	12	16	16



CONTACT LEGEND 16 12 8 4 0

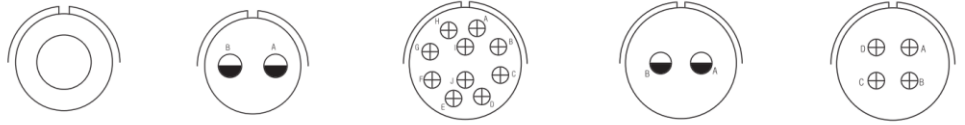

Insert Arrangement	16-12	16-13	18-1	18-3	18-4
Service Rating	A	A	B, C, F, G=A; Bal.=Inst	D	D
Number of Contacts	1	2	10	2	4
Contact Size	4	12	16	12	16

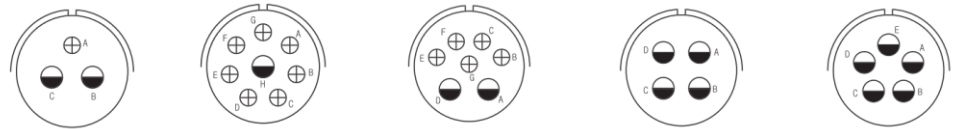

Insert Arrangement	18-5	18-8	18-9	18-10	18-11
Service Rating	D	A	Inst.	A	A
Number of Contacts	2 1	1 7	2 5	4	5
Contact Size	12 16	12 16	12 16	12	12

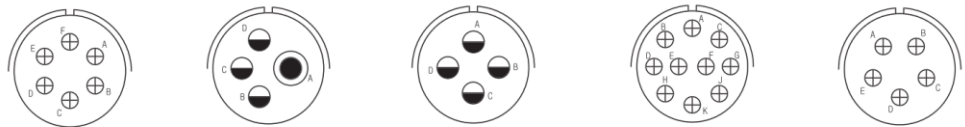

Insert Arrangement	18-12	18-13	18-15	18-19	18-20
Service Rating	A	A	A	A	A
Number of Contacts	6	1 3	4	10	5
Contact Size	16	8 12	12	16	16



CONTACT LEGEND 16 12 8 4 0

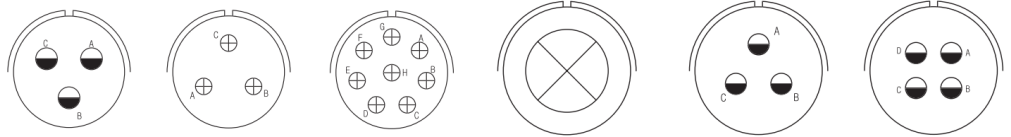

Insert Arrangement	18-21	18-22	18-32	20-2	20-3	20-4
Service Rating	A	D	A	D	D	D
Number of Contacts	3	3	8	1	3	4
Contact Size	12	16	16	0	12	12

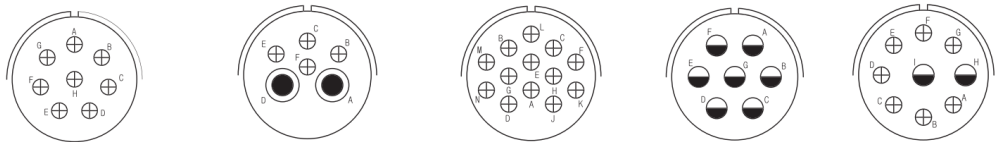

Insert Arrangement	20-7	20-8	20-11	20-15	20-16
Service Rating	H, G=D: C, D, E, F=A	Inst.	Inst.	A	A
Number of Contacts	8	2 4	13	7	2 7
Contact Size	16	8 16	16	12	12 16



Insert Arrangement	20-17	20-18	20-19	20-22
Service Rating	A	A	A	A
Number of Contacts	5 1	3 6	3	3 3
Contact Size	12 16	12 16	8	8 16



CONTACT LEGEND 16 12 8 4 0

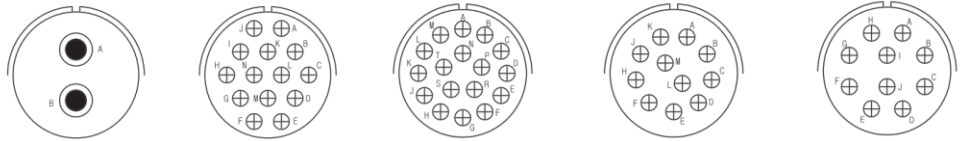

Insert Arrangement	20-23	20-27	20-29	20-33	20-01
Service Rating	A	A	A	A	A
Number of Contacts	2	14	17	11	10
Contact Size	8	16	16	16	16

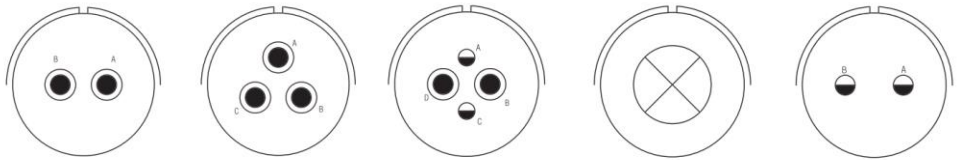

Insert Arrangement	22-1	22-2	22-4	22-7	22-8
Service Rating	D	D	A	E	E
Number of Contacts	2	3	2 2	1	2
Contact Size	8	8	8 12	0	12

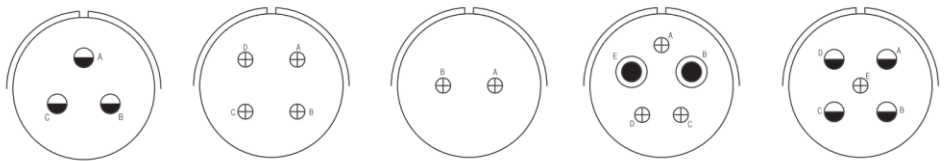

Insert Arrangement	22-9	22-10	22-11	22-12	22-13
Service Rating	E	E	B	D	E=D; A, B, C, D=A
Number of Contacts	3	4	2	2 3	4 1
Contact Size	12	16	16	8 16	12 16



CONTACT LEGEND 16 12 8 4 0

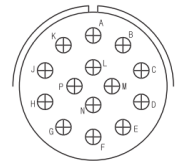
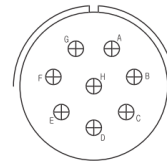
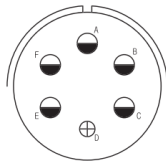
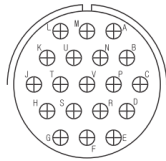

Insert Arrangement	22-14	22-15	22-18	22-19
Service Rating	A	D=E; A, B, C, E, F=A	A,B,F,G,H=D;C,D,E=A	A
Number of Contacts	19	5 1	8	14
Contact Size	16	12 16	16	16

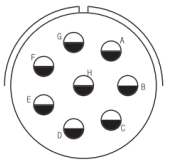
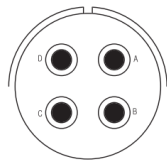
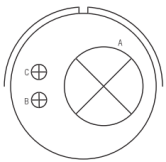
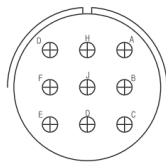

Insert Arrangement	22-20	22-21	22-22	22-23
Service Rating	A	A	A	H=D; Bal.=A
Number of Contacts	9	1 2	4	8
Contact Size	16	0 16	8	12

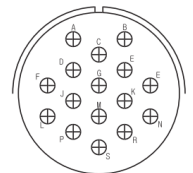
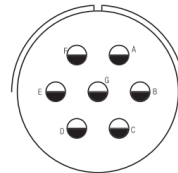
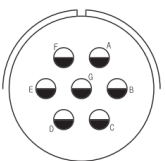
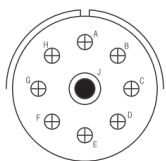

Insert Arrangement	22-27	22-28	24-2	24-5
Service Rating	J=D; Bal.=A	A	D	A
Number of Contacts	1 8	7	7	16
Contact Size	8 16	12	12	16

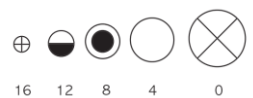

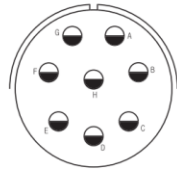

24-6
 A, G, H=D; Bal.=A
 Service Rating 8
 Number of Contacts 12

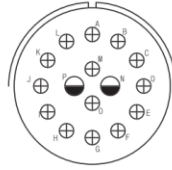

24-7
 A
 Service Rating 2 14
 Number of Contacts 12 16

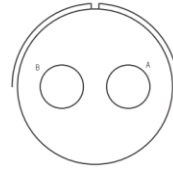

24-9
 A
 Service Rating 2
 Number of Contacts 4

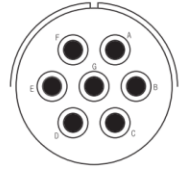

24-10
 A
 Service Rating 7
 Number of Contacts 8

Insert Arrangement
 Service Rating
 Number of Contacts
 Contact Size

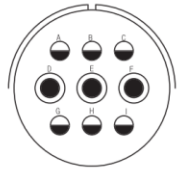

24-11
 A
 Service Rating 3 6
 Number of Contacts 8 12

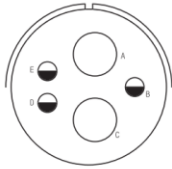

24-12
 A
 Service Rating 2 3
 Number of Contacts 4 12

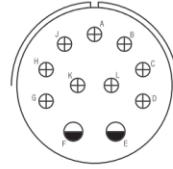

24-20
 D
 Service Rating 2 9
 Number of Contacts 1 16

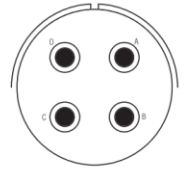

24-22
 D
 Service Rating 4
 Number of Contacts 8

Insert Arrangement
 Service Rating
 Number of Contacts
 Contact Size

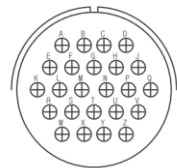

24-28
 Inst.
 Service Rating 24
 Number of Contacts 16

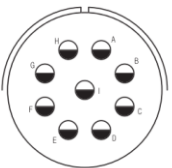

24-02
 A
 Service Rating 9
 Number of Contacts 12

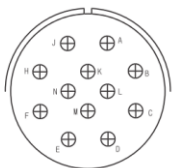

24-03
 A
 Service Rating 12
 Number of Contacts 16

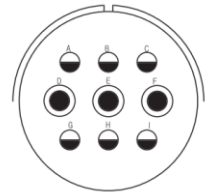

28-1
 A, J, E=D; Bal.=A
 Service Rating 3 6
 Number of Contacts 8 12

Insert Arrangement
 Service Rating
 Number of Contacts
 Contact Size

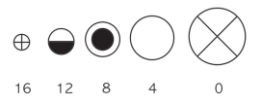

CONTACT LEGEND

16 12 8 4 0

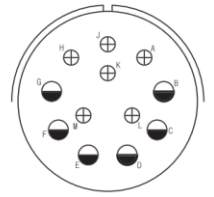
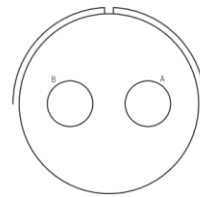
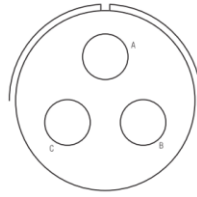
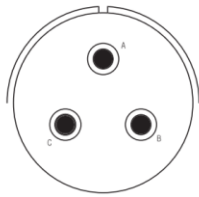

Insert Arrangement
 Service Rating
 Number of Contacts
 Contact Size

28-3
 E
 3
 8

28-6
 D
 3
 4

28-7
 D
 2
 4

28-9
 D
 6 6
 12 16

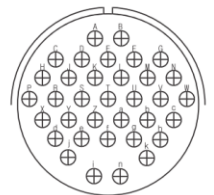
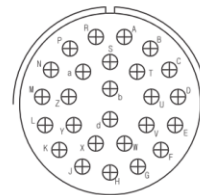
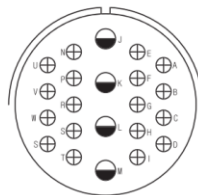
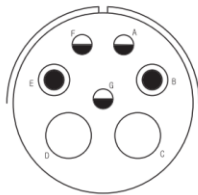

Insert Arrangement
 Service Rating
 Number of Contacts
 Contact Size

28-10
 G=D; Bal. A
 2 2 3
 4 8 12

28-11
 A
 4 18
 12 16

28-12
 A
 26
 16

28-15
 A
 35
 16

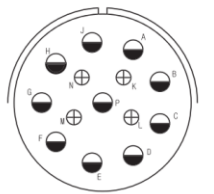
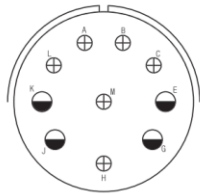
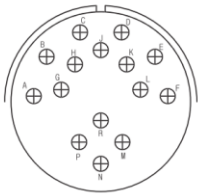
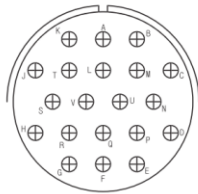

Insert Arrangement
 Service Rating
 Number of Contacts
 Contact Size

28-16
 A
 20
 16

28-17
 R=B; M, N, P=D; A to L=A
 15
 16

28-19
 H, M=B; A, B=D; Bal.=A
 4 6
 12 16

28-20
 A
 10 4
 12 16



CONTACT LEGEND

16 12 8 4 0

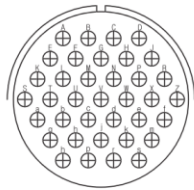

28-21

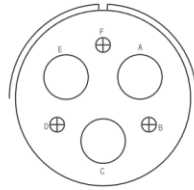

28-22

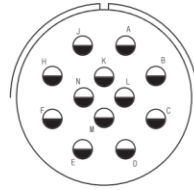

28-51

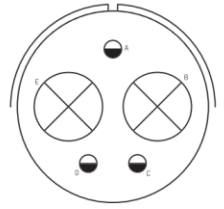

32-1

Insert Arrangement
 Service Rating
 Number of Contacts
 Contact Size

A	D	A	A=E; B, C, D, E=D	
37	3 3	12	2	3
16	4 16	12	0	12

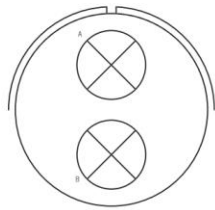

32-5

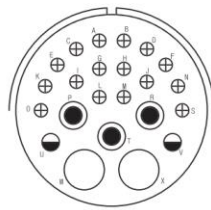

32-6

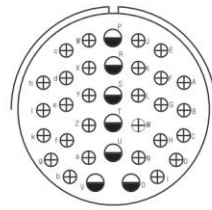

32-7

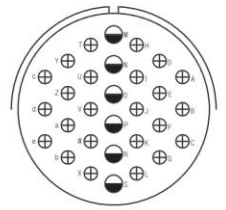

32-8

Insert Arrangement
 Service Rating
 Number of Contacts
 Contact Size

D	A	A, B, h, j=Inst.; Bal.=A		A
2	2 3 2 16	7	28	6 24
0	4 8 12 16	12	16	12 16

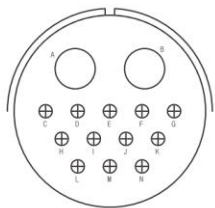

32-9

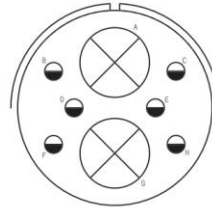

32-15

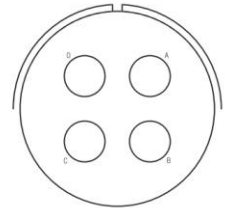

32-17

Insert Arrangement
 Service Rating
 Number of Contacts
 Contact Size

D	D	D
2 12	2 6	4
4 16	0 12	4

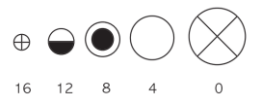

CONTACT LEGEND

16 12 8 4 0

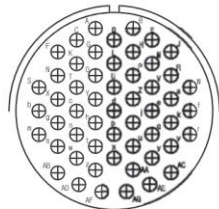

32-22

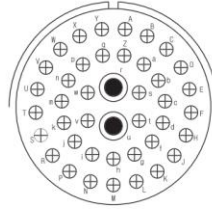

32-59

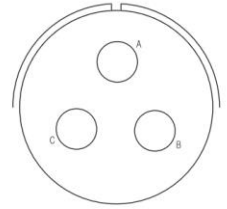

32-03

Insert Arrangement
 Service Rating
 Number of Contacts
 Contact Size

A
 54
 16

A
 2 40
 8 16

A
 3
 4

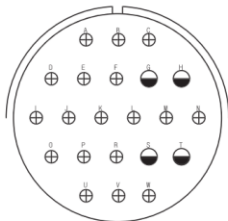

36-1

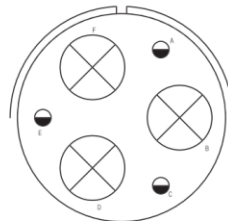

36-3

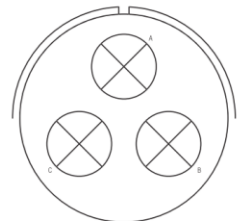

36-4

Insert Arrangement
 Service Rating
 Number of Contacts
 Contact Size

D
 4 18
 12 16

D
 3 3
 0 12

A=D; B, C=A
 3
 0

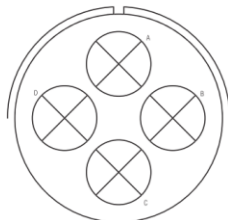

36-5

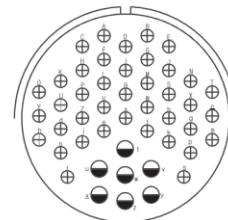

36-7

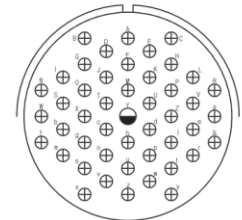

36-8

Insert Arrangement
 Service Rating
 Number of Contacts
 Contact Size

A
 4
 0

A
 7 40
 12 16

A
 1 46
 12 16



CONTACT LEGEND

16 12 8 4 0

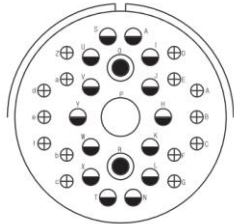

Insert Arrangement 36-9
 Service Rating A
 Number of Contacts 1 2 14 14
 Contact Size 4 8 12 16

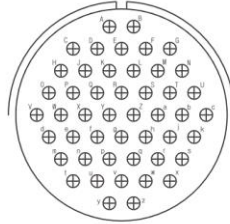

36-10
 A
 48
 16

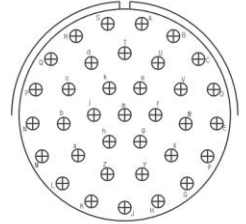

36-15
 M=D; Bal.=A
 35
 16

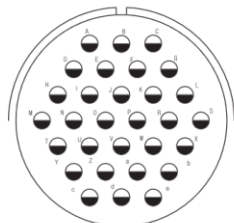

Insert Arrangement 36-30
 Service Rating A
 Number of Contacts 30
 Contact Size 12

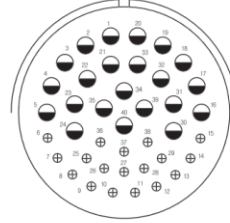

36-40
 A
 22 18
 12 16

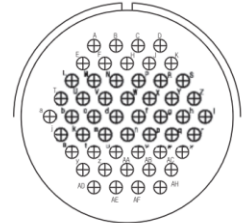

36-52
 A
 52
 16

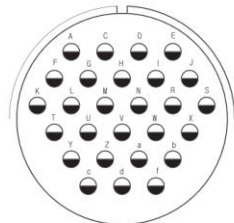

Insert Arrangement 36-02
 Service Rating A
 Number of Contacts 27
 Contact Size 12

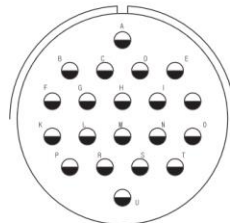

36-03
 A
 20
 12

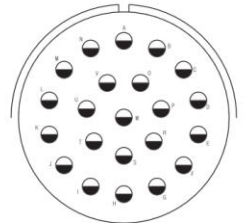

36-04
 A
 22
 12

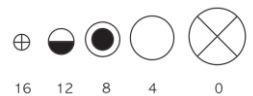

CONTACT LEGEND

16 12 8 4 0

9. Accessories Overview



Plug Protection Cap



Receptacle Protection Cap



Cable Clamp



Telescoping Bushing

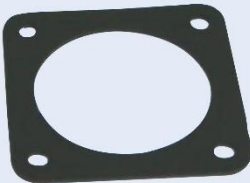

Sealing Gasket

Dust Caps

These metal dust caps are used to protect the plugs and receptacles.

They are furnished with sash chains and are available with bead chains.

MS3057 Cable Clamp

MS3057 style cable clamp was designed for use with jacketed cable or wire protected by tubing. Both clamping halves float maximum strain relief. For unjacketed cable or wires, Use corresponding MS3420 telescoping bushing. Telescoping bushings keep dirt, oil and moisture out of end bell.

Sealing Gasket

Sealing Gasket is being supplied separately

9. Accessories Dimension

MS25042 – Plug Dust Cap

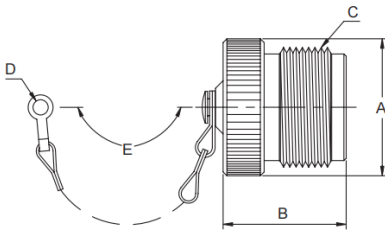

Part Number	Size	Ø A Max	Ø B Max	C Thread 2A	Ø D -0.3	E Approx
MS25042-10D	10S,10SL	18.5	17.2	5/8-24 NEF	4.2	102
MS25042-12D	12S,12	20.4	21.4	3/4-20 NEF	4.2	114
MS25042-14D	14S,14	23.6	21.4	7/8-20 NEF	4.2	114
MS25042-16D	16S,16	26.0	21.4	1-20 NEF	4.2	114
MS25042-18D	18	29.9	21.4	1/8-18 NEF	4.2	114
MS25042-20D	20	33.1	21.4	1/4-18 NEF	4.2*	127
MS25042-22D	22	36.2	21.4	3/8-18 NEF	4.2*	127
MS25042-24D	24	39.4	21.4	1/2-18 NEF	4.2*	140
MS25042-28D	28	45.7	21.4	3/4-18 NS	4.2*	197
MS25042-32D	32	52.0	21.4	2-18 NS	4.2**	197
MS25042-36D	36	59.0	21.4	1/4-16 UN	4.2**	197

These externally threaded metal dust caps are used to protect the MS3106 and MS3108 plugs.

Material is aluminum alloy. They are furnished with sash chains and are available with bead chains.

Optional termination holes are also available. (*5.0)(**5.8)

MS25043 – Receptacle Dust Caps

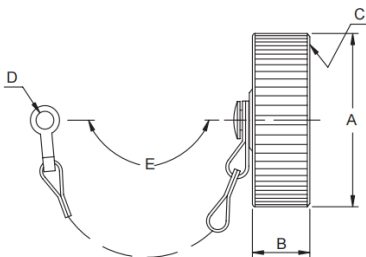

Part Number	Size	Ø A Max	Ø B Max	C Thread 2A	Ø D -0.3	E Approx
MS25043-10D	10S,10SL	20.2	15.8	5/8-24 NEF	4.2	102
MS25043-12D	12S,12	23.4	15.8	3/4-20 NEF	4.2	114
MS25043-14D	14S,14	27.9	15.8	7/8-20 NEF	4.2	114
MS25043-16D	16S,16	29.8	15.8	1-20 NEF	4.2	114
MS25043-18D	18	32.2	15.8	1 1/8-18 NEF	4.2	114
MS25043-20D	20	36.3	15.8	1 1/4-18 NEF	4.2	127
MS25043-22D	22	39.9	15.8	1 3/8-18 NEF	4.2	127
MS25043-24D	24	43.7	15.8	1 1/2-18 NEF	4.2*	140
MS25043-28D	28	50.0	15.8	1 3/4-18 NS	4.2*	197
MS25043-32D	32	56.5	15.8	?2-18 NS	4.2**	197
MS25043-36D	36	61.5	15.8	2 1/4-16 UN	4.2**	197

These internally threaded metal dust caps are used to protect MS3100, MS3101, and MS3102 receptacles.

Material is aluminum alloy. They are furnished with sash chains and are available with bead chains.

Optional termination holes are also available. (*4.58)(**5.00)

MS3057 – Cable Clamp

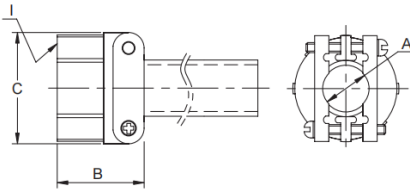

Part Number	Size	Ø A ±0.4	B ±0.8	Ø C ±0.8	I Thread-2B
MS3057-4A	10SL, 12S	5.6	20.3	23.3	5/8-24 NEF
MS3057-6A	14S, 14	7.9	22.5	25.9	3/4-20 NEF
MS3057-8A	16S, 16	11.1	24.4	28.9	7/8-20 NEF
MS3057-10A	18	14.3	23.6	32.2	1-20 NEF
MS3057-12A	20, 22	15.9	23.6	37.8	1 3/16-18 NEF
MS3057-16A	24, 28	19.1	26.0	43.4	1 7/16-18 NEF
MS3057-20A	32	23.8	27.7	52.1	1 3/4-18 NS
MS3057-24A	36	31.8	29.2	57.3	2-18 NS

MS3057 style cable clamp was designed for use with jacketed cable or wire protected by tubing.

Both clamping halves float maximum strain relief. For unjacketed cable or wires, use corresponding MS3420 telescoping bushing. To order clamp without bushing, add -1 to the P/N.

MS3420 – Telescoping Bushing

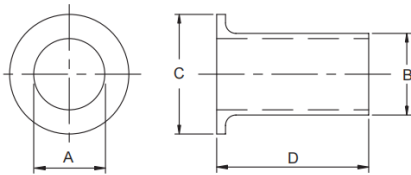

Part Number	Size	Ø A Max	Ø B Max	Ø C	D
MS3420-4	10SL, 12S	5.6	7.7	12.8	69.9
MS3420-6	14S, 14	7.9	10.9	15.7	66.7
MS3420-8	16S, 16	11.1	14.0	18.9	63.5
MS3420-10	18	14.3	15.6	22.6	60.3
MS3420-12	20, 22	15.9	18.8	27.5	57.2
MS3420-16	24, 28	19.1	23.6	33.4	54.0
MS3420-20	32	23.8	31.5	40.6	50.8
MS3420-24	36	31.8	34.7	46.9	47.6

Telescoping grand bushings (used with 3057 clamps) keep dirt, oil, and moisture out of endbell.

Taping or wrapping wires is eliminated since bushing protects wires going through clamp.

Combinations of bushing may be used to decrease cable entry diameter to improve sealing.

BMA 31 – Sealing Gasket

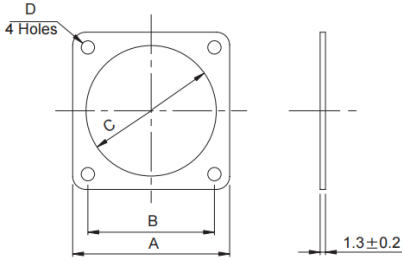

Part Number	Shell Size	□ A	□ B	∅ C	D +0.2
BMA31-10	10S,10SL	25.40	18.26	14.9	3.2
BMA31-12	12S,12	27.79	20.62	16.4	3.2
BMA31-14	14S,14	30.18	23.01	20.4	3.2
BMA31-16	16S,16	32.54	24.61	23.0	3.2
BMA31-18	18	34.94	26.97	25.9	3.2
BMA31-20	20	38.10	29.36	29.1	3.2
BMA31-22	22	41.28	31.75	32.0	3.2
BMA31-24	24	44.45	34.93	35.3	3.8
BMA31-28	28	50.80	39.67	41.5	3.8
BMA31-32	32	57.15	44.45	47.5	4.6
BMA31-36	36	63.50	49.23	54.7	4.6

The flat gasket of synthetic rubber material is provided to take complete advantage of waterproof and pressure sealing features. It is use with the flange mounted receptacle.

Panel Mounting Hole(Reference)

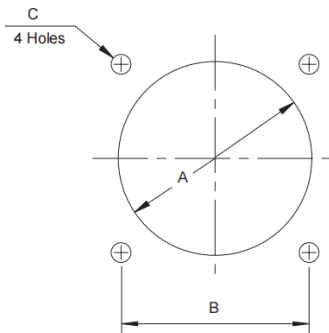

Shell Size	∅ A ± 0.5	□ B ± 0.12	C +0.2
10SL	17.5	18.26	3.2
12S	18.5	20.62	3.2
12	18.5	20.62	3.2
14S	22.0	23.01	3.2
14	22.0	23.01	3.2
16S	25.0	24.61	3.2
16	25.0	24.61	3.2
18	30.0	26.97	3.2
20	33.0	29.36	3.2
22	35.0	31.75	3.2
24	39.0	34.93	3.8
28	45.0	39.67	3.8
32	52.0	44.45	4.6
36	59.0	49.23	4.6

Thank You!