

M12 Female Connector, Shielded Field Wireable, PG7

Features:

- Threaded Coupling
- IP67 (Rating)
- Pollution Degree: 3
- Suitable Cable Dia: 4~6mm
- Wire Gauge: 2~5P: 22AWG; 6~8P: 24AWG
- Products Comply With IEC 61076-2-101 Industry 4.0 Agreement, NEMA2000 Standard



Electrical Specifications								
Contacts	2	3	4	4D	5	5B	6	8
Rated Current (A)	4	4	4	4	4	4	2	2
Rated Voltage (AC,V)	250	250	250	250	60	60	30	30
Rated Pulse Voltage (AC,V)	2500	2500	2500	2500	1500	1500	800	800
Insulation Resistance (MΩ)	≥100	≥100	≥100	≥100	≥100	≥100	≥100	≥100
Contact Resistance (mΩ)	≤5	≤5	≤5	≤5	≤5	≤5	≤5	≤5
Insulation Resistance (MΩ)	≥1000	≥1000	≥1000	≥1000	≥1000	≥1000	≥1000	≥1000

Mechanical Specifications	
Mating Cycles	500 Min
Coupling Mechanism	Threaded
Interface Specification	IEC 61076-2-101

Environmental Specifications	
Temperature Range	-40°C to +80°C

Material Specifications	
Shell	Zinc Alloy, Nickel Plating
Hex Nut	Zinc Alloy, Nickel Plating
Insulator	PA66 UL94-V0, Black
Contacts	Copper Alloy, Gold Plating
Sealing Ring	NBR, Black

Drawing

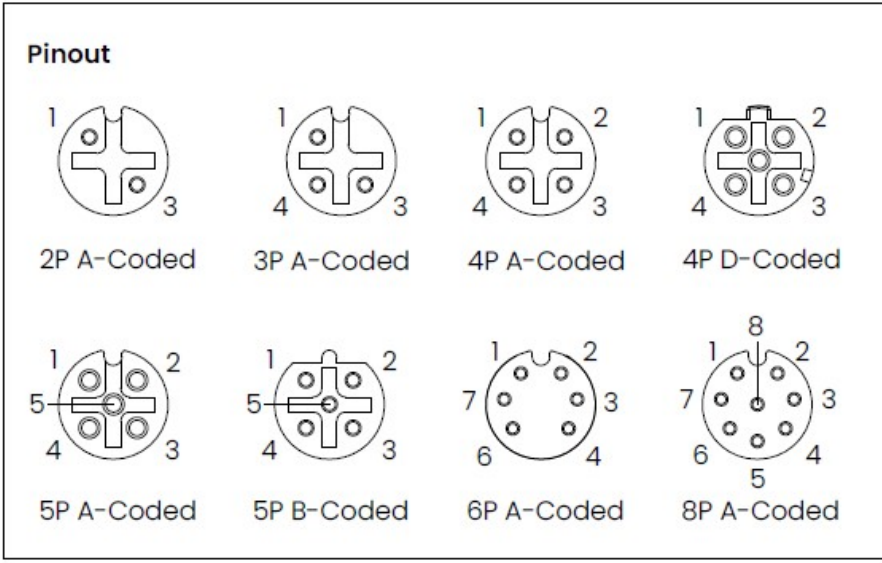
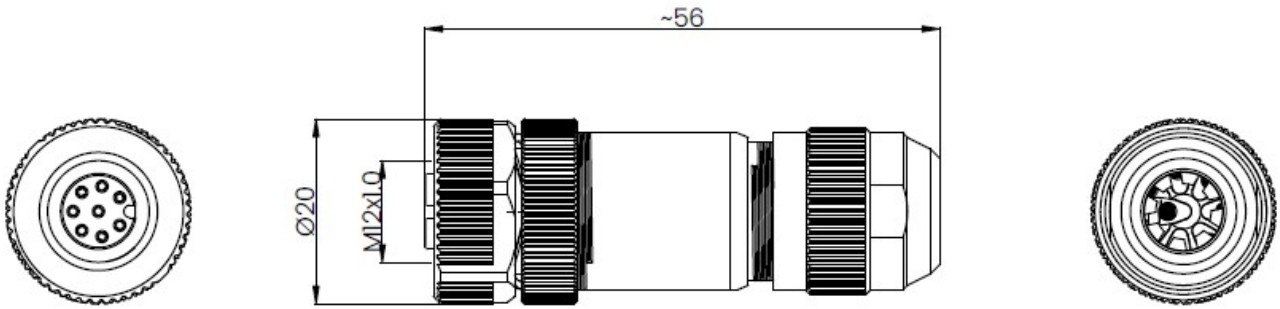

Part Number:
M12-XX-X-S-4-S-PG7

Code:
A, B, D

Number of Contacts:
02, 03, 04, 05, 06, 08

UNLESS OTHERWISE SPECIFIED
TOLERANCES FOR MILLIMETERS
ARE:
0.5 - 8mm ± 0.20 mm
8 - 30mm ± 0.25 mm
30 - 120mm ± 0.30 mm

Disclaimer

The information in this specification is subject to change without notice. Please confirm the latest version before use. Technical parameters are for reference only, and sufficient testing and verification should be conducted in actual applications.